

BERNINA®



BERNINA® 1006
Electronic

Instruction Manual



BERNINA® 1006
Electronic

IMPORTANT SAFETY INSTRUCTIONS

When using an electrical appliance, basic safety precautions should always be followed, including the following:
Read all instructions before using this sewing machine.

DANGER

To reduce the risk of electric shock:

1. An appliance should never be left unattended when plugged in.
2. Always unplug this appliance from the electric outlet immediately after using and before cleaning.
3. Always unplug before relamping. Replace bulb with same type rated 15 Watts.

WARNING

To reduce the risk of burns, fire, electric shock, or injury to persons:

1. Do not allow to be used as a toy. Close attention is necessary when this appliance is used by or near children.
2. Use this appliance only for its intended use as described in this manual. Use only attachments recommended by the manufacturer as contained in this manual.
3. Never operate this appliance if it has a damaged cord or plug, if it is not working properly, if it has been dropped or damaged, or dropped into water. Return the appliance to the nearest authorized dealer or service center for examination, repair, electrical or mechanical adjustment.
4. Never operate the appliance with any air openings blocked. Keep ventilation openings of the sewing machine and foot controller free from accumulation of lint, dust, and loose cloth.
5. Keep fingers away from all moving parts. Special care is required around the sewing machine needle.
6. Always use the proper needle plate. The wrong plate can cause the needle to break.
7. Do not use bent needles.
8. Do not pull or push fabric while stitching. It may deflect the needle causing it to break.
9. Switch the sewing machine off when making any adjustments in the needle area, such as threading needle, changing needle, threading bobbin, or changing presser foot, and the like.
10. Always unplug sewing machine from the electrical outlet when removing covers, lubricating, or when making any other user servicing adjustments mentioned in the instruction manual.
11. Never drop or insert any object into any opening.
12. Do not use outdoors.
13. Do not operate where aerosol (spray) products are being used or where oxygen is being administered.
14. To disconnect, turn all controls to the off position, then remove plug from outlet.
15. Do not unplug by pulling on cord. To unplug, grasp the plug, not the cord.

GROUNDING INSTRUCTIONS (for U.S.A. only)

This product must be grounded. In the event of malfunction or breakdown, grounding provides a path of least resistance for electric current to reduce the risk of electric shock. This product is equipped with a cord having an equipment-grounding conductor and a grounding plug. The plug must be plugged into an appropriate outlet that is properly installed and grounded in accordance with all local codes and ordinances.

DANGER

Improper connection of the equipment-grounding conductor can result in a risk of electric shock. The conductor with insulation having an outer surface that is green with or without yellow stripes is the equipment-grounding conductor. If repair or replacement of the cord or plug is necessary, do not connect the equipment-grounding conductor to a live terminal.

Check with a qualified electrician or serviceman if the grounding instructions are not completely understood, or if in doubt as to whether the product is properly grounded.

Do not modify the plug provided with the product - if it will not fit the outlet, have a proper outlet installed by a qualified electrician.

This product is for use on a nominal 120V circuit, and has a grounding plug that looks like the plug illustrated in sketch A. A temporary adaptor, which looks like the adaptor illustrated in sketches B and C, may be used to connect this plug to a 2-pole receptacle as shown in sketch B if a properly grounded outlet is not available. The temporary adaptor should be used only until a properly grounded outlet can be installed by a qualified electrician. The green colored rigid ear, lug, and the like, extending from the adaptor must be connected to a permanent ground such as properly grounded outlet box cover. Whenever the adaptor is used, it must be held in place by the metal screw.

GROUNDING METHODS

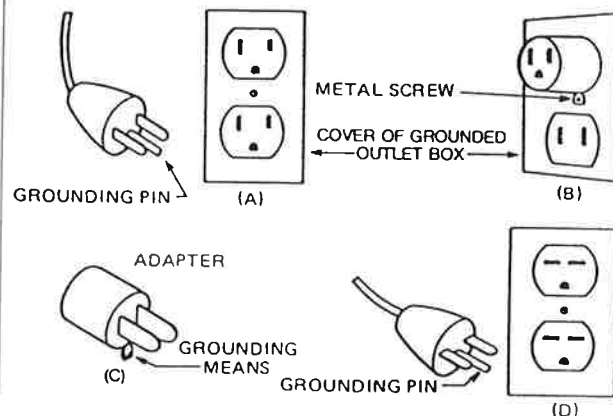

SAVE THESE INSTRUCTIONS

This sewing machine is intended for household use only.

Setting up the sewing machine 1

Presser feet 13
Practical stitches
Practical sewing

Troubleshooting 27
Maintenance

Publications 31

Index 33



Dear BERNINA Customer

Congratulations on choosing a BERNINA 1006. You are now the proud owner of a sewing machine which fulfils every expectation in terms of use and quality. You own a first class product which will give you sewing pleasure for many years to come.

Some hundred years ago, my great grandfather invented the first ever hemstitch machine. This was the beginning of the BERNINA family business and I am proud to be the fourth generation member of the family to have responsibility for the company. I am delighted to welcome you to the millions of satisfied BERNINA owners around the world.

If you require any further information about your sewing machine or sewing in general, please do not hesitate to contact your BERNINA dealer, who will be delighted to help you.

I wish you very happy and successful sewing.

Yours truly,

Hanspeter Ueltschi
President

BERNINA®

Display/Control panel

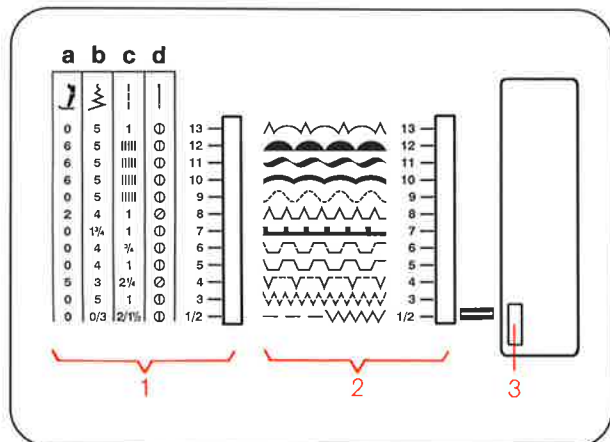

- 1 Basic setting panel
 - a. Presser foot
 - b. Stitch width
 - c. Stitch length
 - d. Needle position
- 2 Stitch programme
- 3 Selector lever
- 4 Stitch width knob
- 5 Needle position knob
- 6 Buttonhole knob
- 7 Stitch length knob
- 8 Feed-dog knob

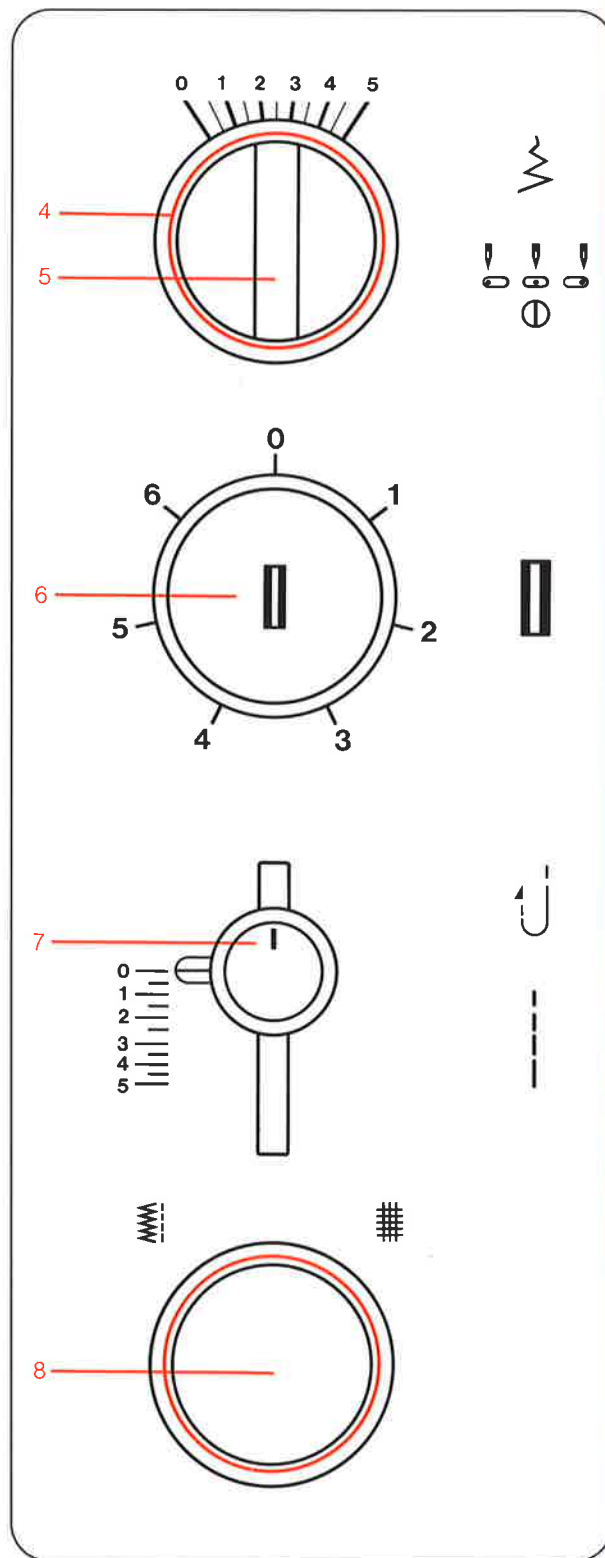

Details of machine

- 1 Hinged front cover
- 2 Stitch plate
- 3 Presser foot
- 4 Needle clamp
- 5 Thread regulator
- 6 Thread take-up lever
- 7 Pre-tension stud
- 8 Thread tension slot
- 9 Thread tension adjustment knob
- 10 Basic setting
- 11 Stitch programme
- 12 Selector lever
- 13 Bobbin spindle
- 14 Bobbin winder stop
- 15 Handwheel
- 16 Stitch width knob
- 17 Needle position knob
- 18 Buttonhole knob
- 19 Power/light switch
- 20 Stitch length knob
- 21 Securing pins for sewing table
- 22 Combined mains/foot control socket
- 23 Knob for sewing/darning
- 24 Presser foot lever
- 25 Carrying handle
- 26 Thread guide
- 27 Thread holder pins
- 28 Supplementary thread guide
- 29 Thread cutter

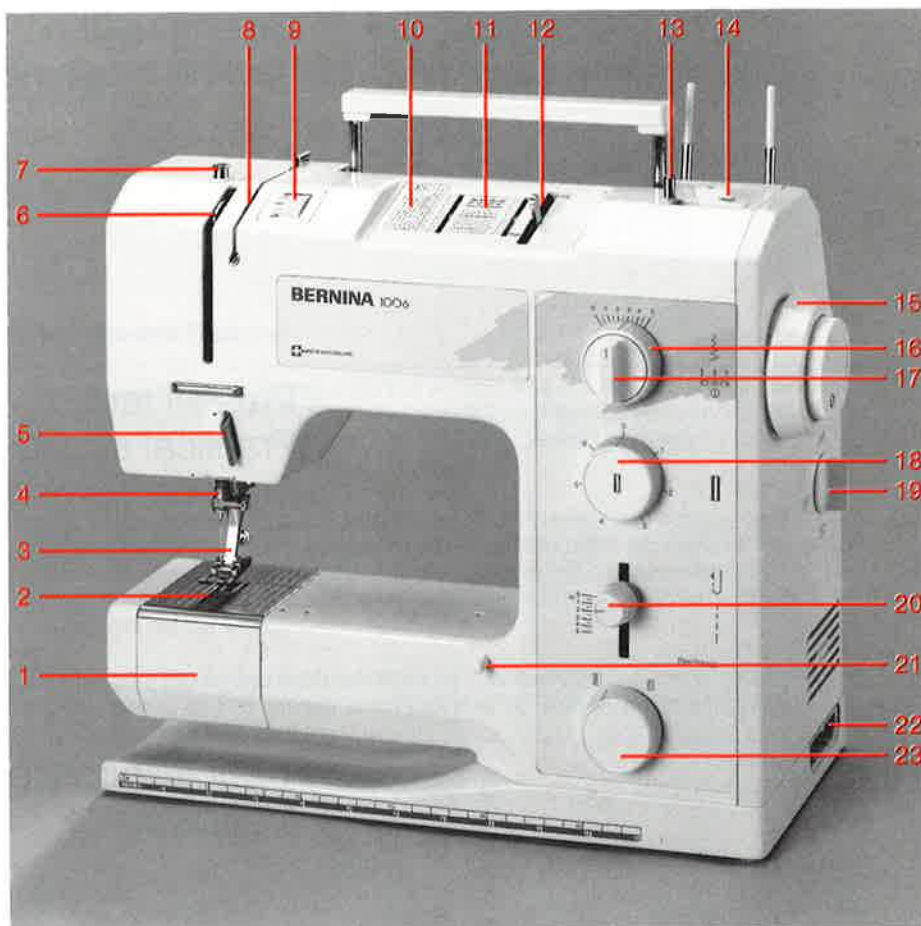

Setting up the sewing machine

Cover, accessories



Cover, accessories

The cover protects the machine from dust and dirt.

The outside pocket provides storage for the instruction manual, foot control and cable.

The machine is very easy to carry with the practical, retractable handle.

Standard accessories

- 6 bobbins
- Needle assortment
- Seam ripper
- Small screwdriver
- Special screwdriver
- Bulb holder
- Cleaning brush
- Oiler, filled
- Zig-zag presser foot
- Overlock foot
- Buttonhole foot
- Zip foot
- Blind stitch foot
- Embroidery foot

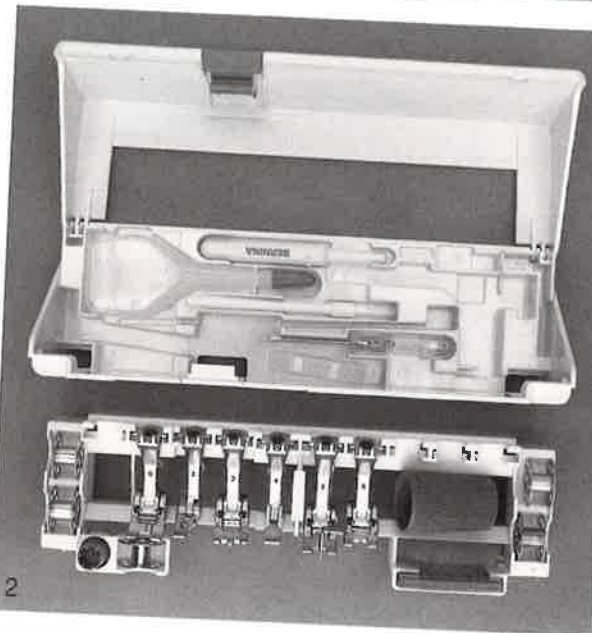

Accessories box

The accessories are neatly stored in the accessories box (Fig. 2).

Fitting the accessories box onto the machine

The accessories box has two fixing lugs that fit into the base plate of the machine.

Removing the accessories box

Simply push the accessories box backwards (Fig. 3).

Lay the accessories box onto the base plate of the rear and press against the free arm until the fixing lugs engage in the holes provided (Fig. 4).

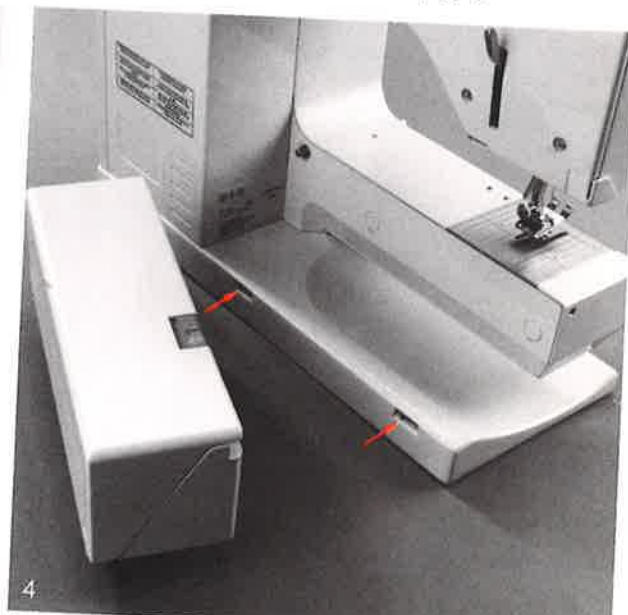
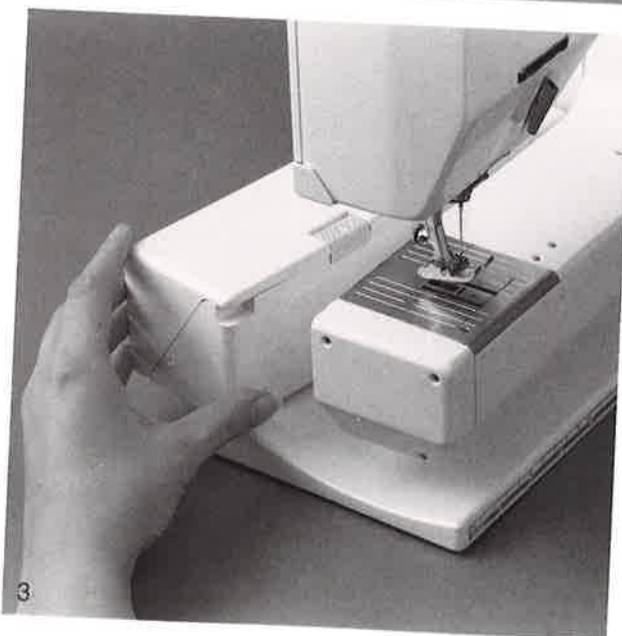

Mains cable, foot control unit, sewing light, power switch



Connecting mains cable and foot control unit

Plug the specially combined mains/foot control cable into the machine. Plug the foot control cable into the foot control and the machine cable into the mains socket.



Foot control unit

This is used to regulate the sewing speed.

The sewing speed can be controlled from virtually 0 to maximum speed by varying the pressure on the plate of the foot control unit.

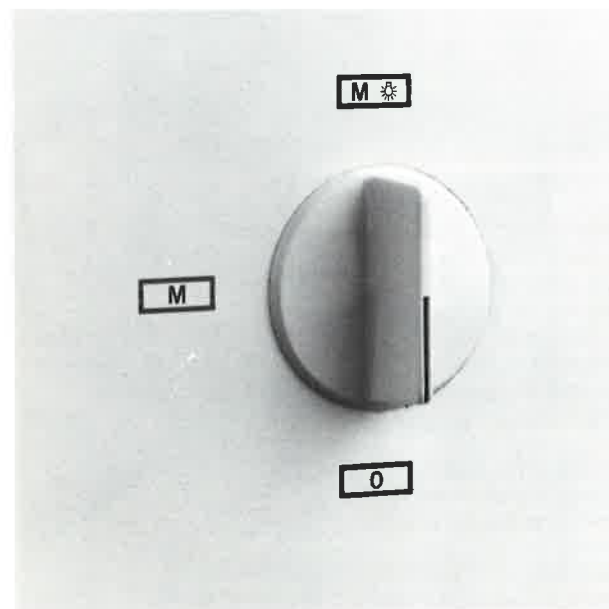

Power switch sewing light

The power switch below the handwheel has 3 positions:

0 **Off** The machine is switched off.

M **On** The machine is switched on.

M * The machine and sewing light are switched on.

Bobbin case and bobbin, winding lower thread

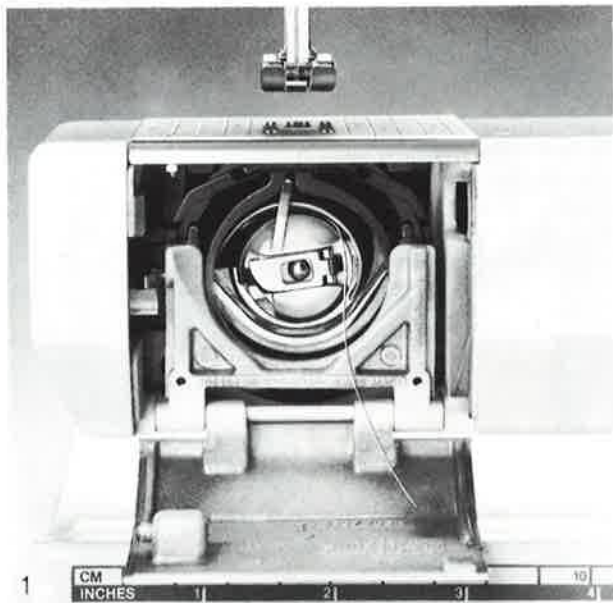

Removing the bobbin case

Set the power switch to the 0 position.

Check that the needle is raised. Open the hinged front cover on the free arm (Fig. 1).

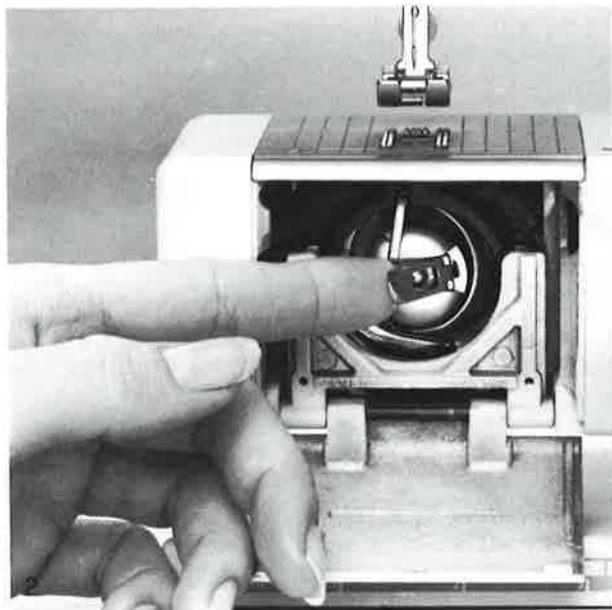

With the index finger and thumb of the left hand, pull the bobbin case latch forward and remove the bobbin case (Fig. 2).



Winding lower thread

Holding the handwheel with the left hand, turn the handwheel release forward with the right hand. The sewing machine is now disengaged (Fig. 3). Place empty bobbin on the spindle and press it to the right against the bobbin winder stop. The bobbin winder is now engaged.

Take thread from the reel of thread on the thread holder pin and pass it clockwise around the pre-tension stud to the empty bobbin. Wind around the empty bobbin several times, again in a clockwise direction (Fig. 4).

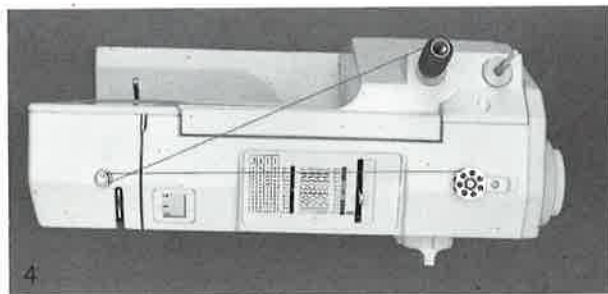

WARNING:

Please refer to the safety instructions.

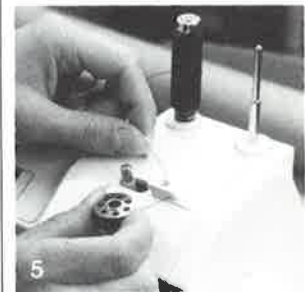

When removing the bobbin, cut the thread by pulling it to the left against the bobbin winder stop (Fig. 5).

Press on the foot control to start the motor. When the bobbin is full, the bobbin winder will stop automatically. Push bobbin to left and remove.

Inserting the bobbin



Inserting the bobbin

Hold the bobbin case in the left hand.
Insert the bobbin with the thread running in a clockwise direction, see arrow.

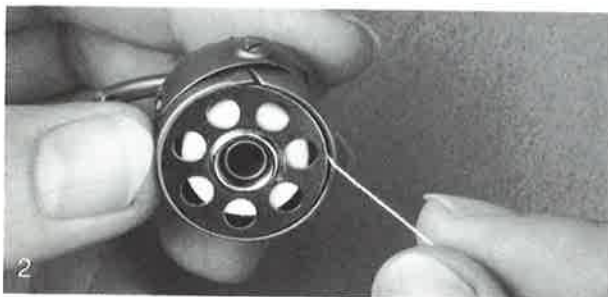

Take the thread anti-clockwise to the slot.

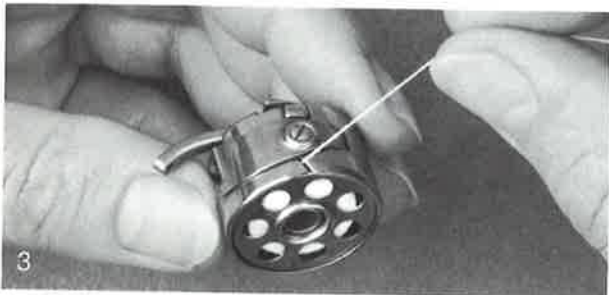

Pull the thread into the slot and under the spring, until it lies in the T-shaped slot at the end of the spring.



When the end of the thread is pulled, the bobbin should turn clockwise, in the direction of the arrow.

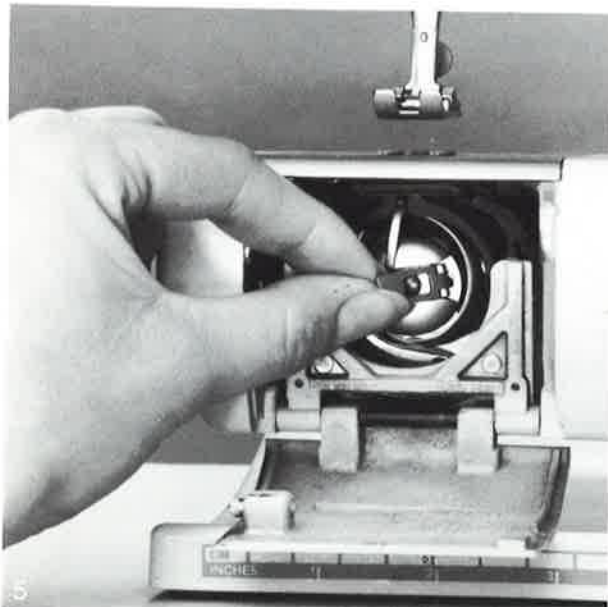

Inserting the bobbin case into the hook

Hold the bobbin case by the latch with the index finger and thumb of the left hand. Insert so that the finger of the bobbin case points upwards, engaging in the notch of the hook race cover.
Check: Pull end of thread. Close the hinged front cover.

Threading the upper thread

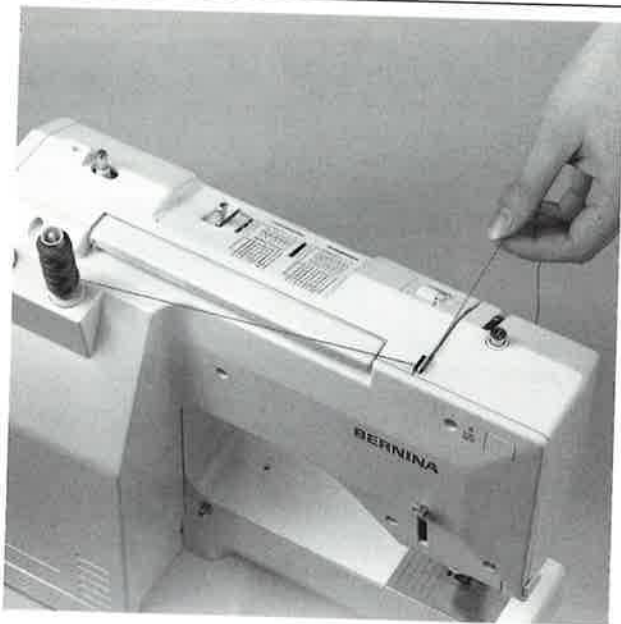

Thread the upper thread

Check that the needle is in the raised position. Raise the presser foot.

Place the reel of thread on one of the two thread holder pins.

Firmly clip the thread into the thread guide on the top of the machine. Then pull it through the long slot (A) into the thread tension.

WARNING:

Please refer to the safety instructions.

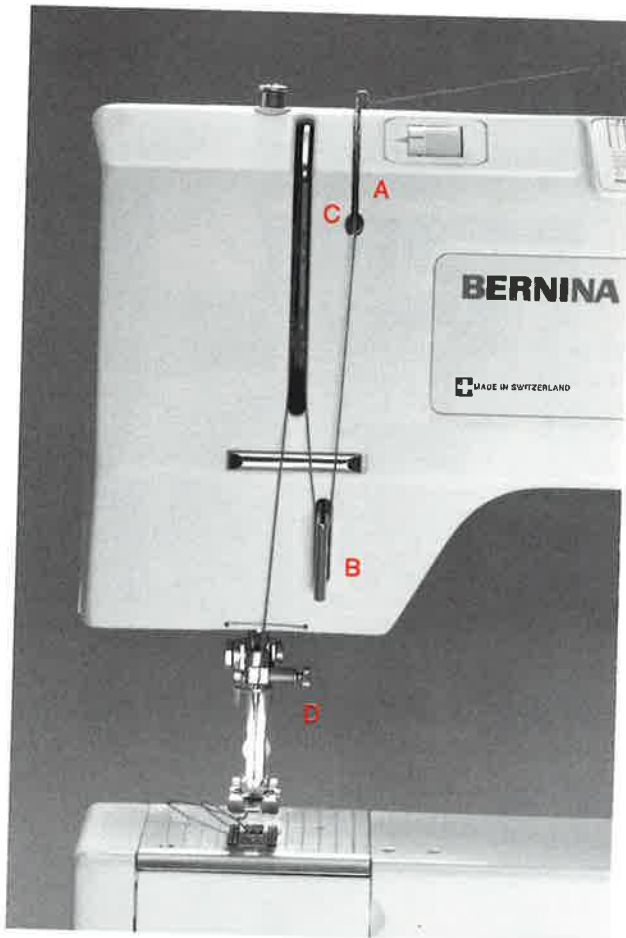

On the front of the machine, take the thread from the slot (A) downwards under the thread regulator (B), then up to the thread take-up lever at the top (C) and down again to the needle holder thread guide (D).

Always thread the needle from front to back.

The small white plate on the front of the presser foot shank helps when threading the needle eye. Pull the thread approx. 10 cm (4") through the needle eye.

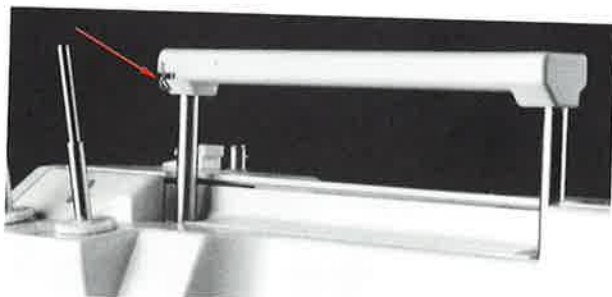

Supplementary thread guide on handle

Sewing with cross-wound reels, metal and silver thread, double or triple needles.

For perfect thread feed, take the thread through the special supplementary thread guide on the handle.

Bringing up the lower thread, thread tension, feed-dog

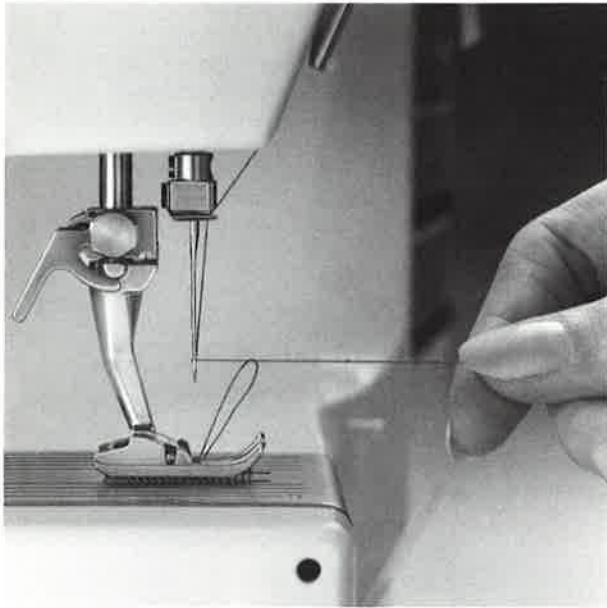

Bringing up the lower thread

Hold the upper thread loosely. Turn the handwheel towards you until the thread take-up lever is fully raised.

Pull the upper thread so that the lower thread is brought up through the stitch plate hole. Take both threads through the slot in the presser foot and place to the side.

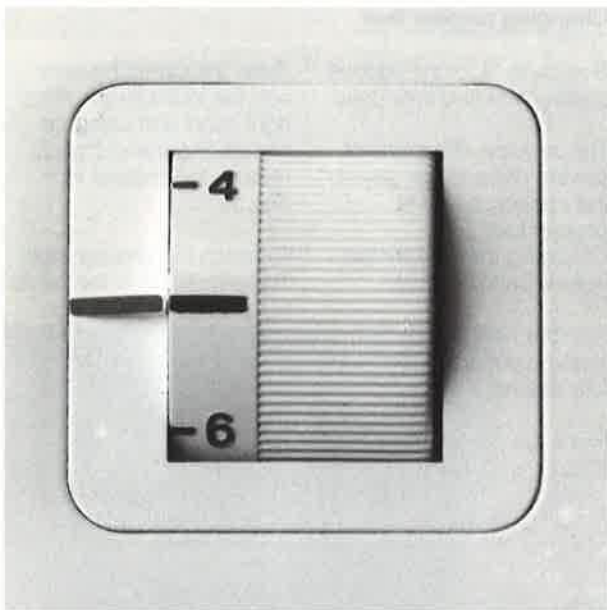

Thread tension

Normal tension is set when the red mark on the regulating dial matches the adjacent mark on the machine.

The thread tension should be adjusted for special sewing, e.g. buttonholes.

Turning the regulating dial forwards to number 4 or below gives a looser upper thread tension.

Turning the regulating dial backwards to number 6 or above gives a tighter upper thread tension.

Do not forget: The thread tension should be reset to normal when special sewing has been completed.

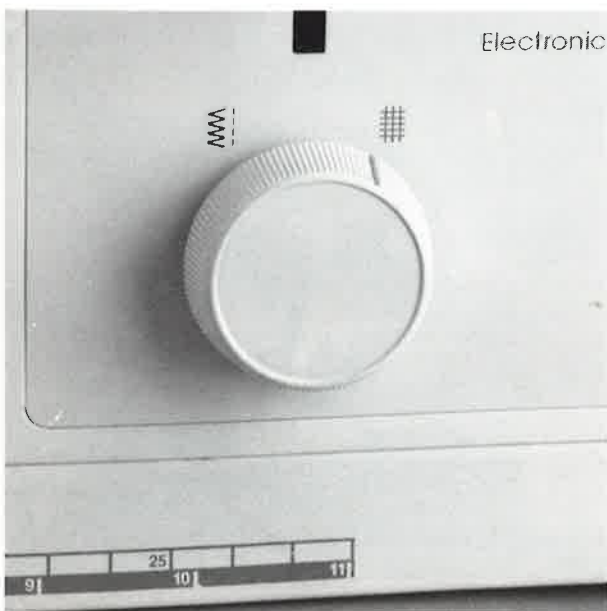

Lowering the feed-dog

For certain types of sewing, e.g. darning, the fabric must not be moved by the feed. Therefore the feed-dog must be lowered by turning the knob to the left until the mark points to the symbol .

For all normal sewing, the mark on the knob should point to symbol .

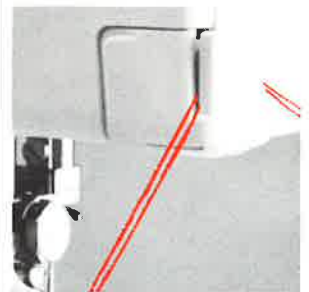

The remove the work, raise the presser foot, pull work out to the rear left and hook both threads into the thread cutter.

The thread ends free themselves when you start sewing again.

Inserting the needle changing presser feet

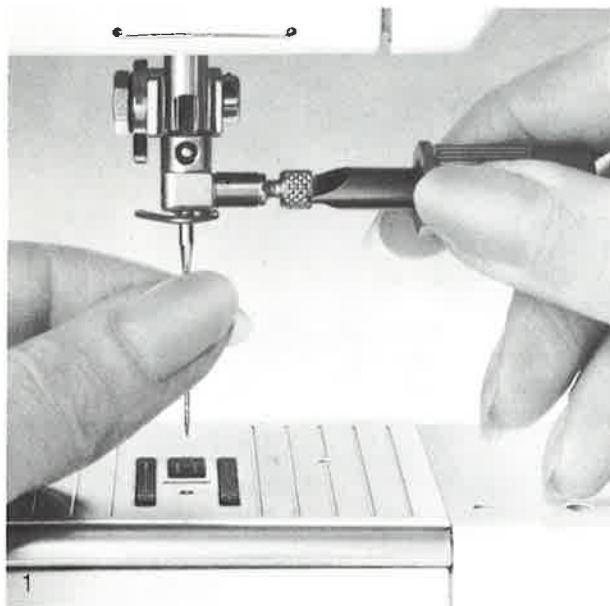

Inserting the needle

The small black screwdriver for loosening or tightening the needle clamp is provided in the accessories box.

Set the power switch to **0**.

Check that the needle is in the raised position. If not, turn the handwheel.

Loosen the needle clamp screw by half a turn (anti-clockwise) and remove the needle (Fig. 1).

Insert a NEW needle – flat side to the rear.

Insert the needle until it reaches the **top**. If the needle is not inserted fully, i.e. is set too low, skipped stitches will result.

Tighten the needle clamp screw securely.

WARNING:

Please refer to the safety instructions.

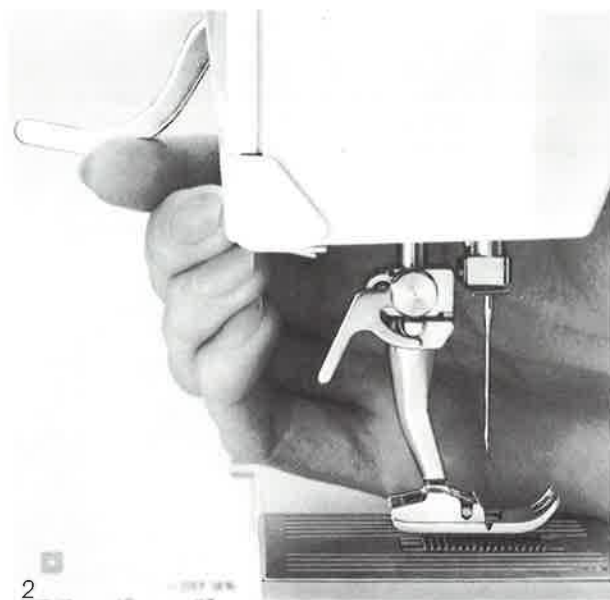

Changing presser feet

See page 14 for the various presser feet and their uses.

The success of a piece of sewing depends largely on the correct choice of presser foot.

Changing the presser feet is easy and practical.

Turn the handwheel towards you until needle is fully raised.

Raise the presser foot (Fig. 2).

Raise the clamping lever with the index finger of the right hand and using the middle finger and thumb, remove the presser foot (Fig. 3).

To attach the presser foot: The procedure is the same but press the clamping lever downwards with the index finger (Fig. 4).

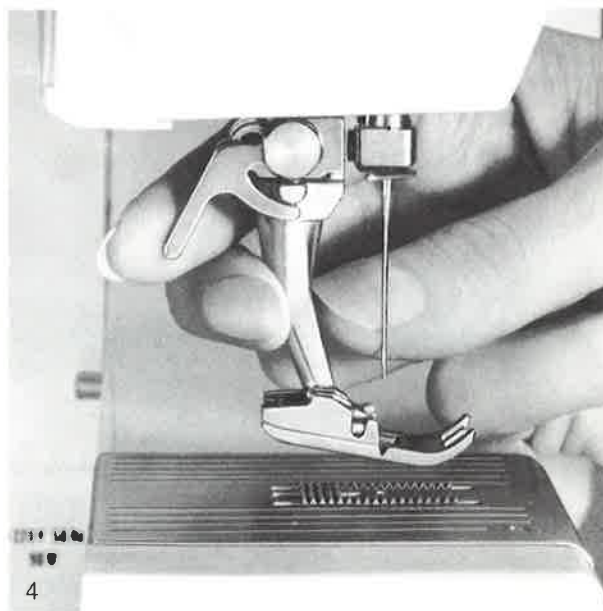
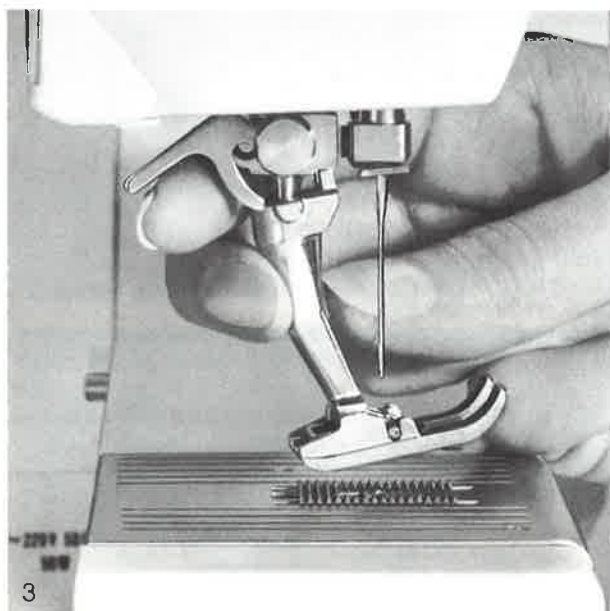

Sewing tips

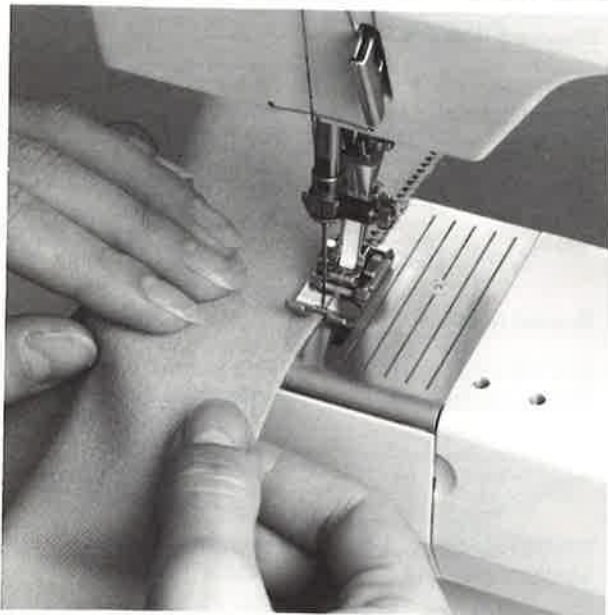

A few hints

Set your BERNINA far enough away from the table edge. Correct sitting position and correct guiding of the work will make sewing easier. Sit right in front of the needle, i.e. in front of the working area.

This will enable you to watch the working area without strain.

Ensure that the height of your chair allows you to work comfortably.

It is best to guide the work from the side with the fingers of the left hand close to the presser foot. When sewing delicate work, it is preferable to stop and guide it a little at a time rather than let the work slide beneath the fingers.

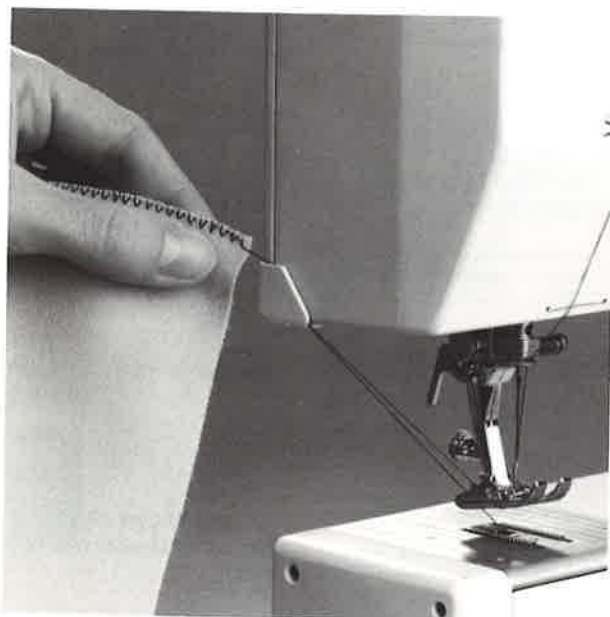

To remove the work, raise the presser foot and check that the needle is raised. If not, turn the handwheel. Take work out to the rear left and hook both threads into the cutter. The thread ends free themselves when you start sewing again.

Threads and needles

Needle table

Needle and sewing machine

Your BERNINA has needle system 130/705H. Make sure when buying new needles that they are the 130/705H system. Commercially available needle sizes are nos. 70 to 120. The finer the needle, the lower the number. The opposite applies to thread. The finer the thread, the higher the number.

Needle and thread

The needle size required depends on the thread selected. The needle must match the thread. When sewing, the thread lies in the long groove on the front of the needle (Fig. 1). If the needle is too fine, the thread will not fit into the groove (Fig. 2) and skipped stitches will result.

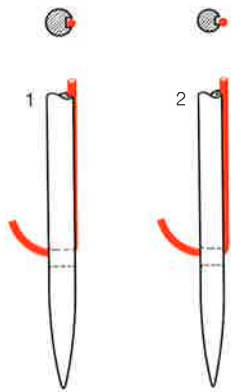

Needle and fabric Condition of needle

The needle must be in perfect condition. Sewing problems are caused by:
 A. bent needles
 B. blunt needles
 C. hooked tips

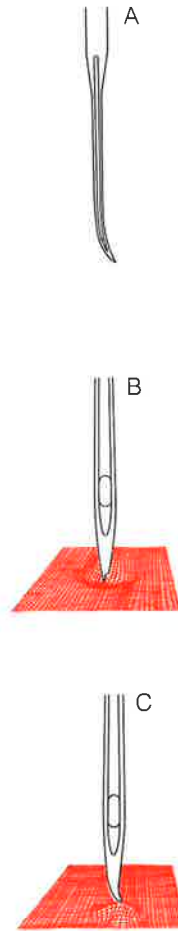

Standard needles

130/705 H
 Normal point, slightly rounded

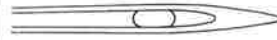

All-purpose needle for woven synthetic and natural fibres, fine linen, chiffon, batiste, organdie, wool, velvet, decorative seams and embroidery.

Special needles

130/705 SES
 Fine ball point



Fine knits, also specially suitable for synthetics.

130/705 H-SUK
 Medium ball point

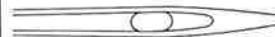

Heavier synthetic or natural fibre knits.

130/705 H-Stretch
 Medium ball-point

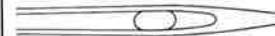

Special needle for delicate or difficult stretch fabrics.

130/705 H-J
 Extra fine point



Twill, workwear, heavy linen, denim, canvas. Penetrates dense fabrics more easily.

130/705 H-LL or H-LR
 Cutting point



Leather, suede, calfskin, kid, pigskin, imitation leathers and suedes, plastics, waxed fabrics.

Needle/Thread Table

Needle	70	80	90	100	110-120
Darning thread	*	*			
Embroidery thread 30		*			
Mercerised cotton sewing thread		*	*		
Synthetic sewing thread		*	*		
Coarse mercerised cotton Mercerised synthetic			*	*	
Buttonhole thread for top stitching (Cordonnet)				*	*

This table shows clearly which needle suits which thread.

Feed-dog and fabric feed

1. Feed-dog and stitch length

With each stitch, the feed-dog moves forward by one step.

The length of this step is governed by the stitch length selected.

With an extremely short stitch length, the steps are extremely short. The fabric moves under the presser foot slowly.

For example, buttonholes and satin stitching are sewn with this short stitch length.

Important

a) Make sure that the fabric feeds evenly!



b) Pulling or pushing will result in "gaps".



c) Holding back will result in "pile-ups".



2. Feed-dog and fabric feed

a) The feed-dog can only work effectively if the presser foot is horizontal.

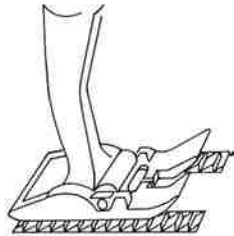

b) If the presser foot is tilted, e.g. at a very thick seam or hem, the feed-dog will be unable to grip the fabric. The work will stick.

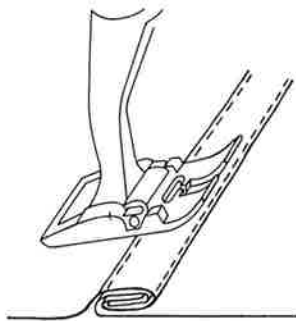

c) Place a piece of fabric, neatly folded to the thickness of the seam, beside the sewing so that the presser foot is level again.

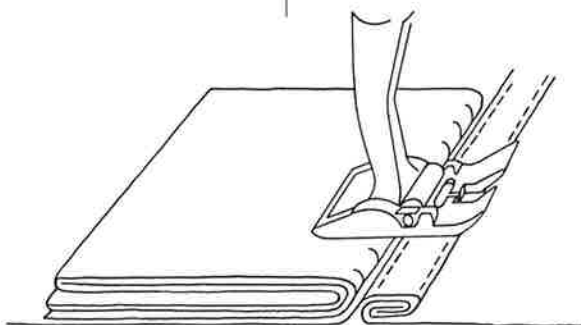

3. Feed-dog and sewing corners

a) The two rows of teeth of the feed-dog are quite a distance apart because of the width of the needle hole.



b) When sewing corners, only a small part of the fabric is on the feed-dog so it cannot transport the work correctly.

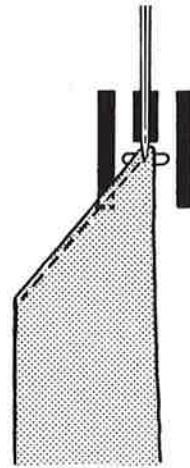

c) If a folded piece of fabric is placed against the corner, the feed-dog will be able to do its job properly.

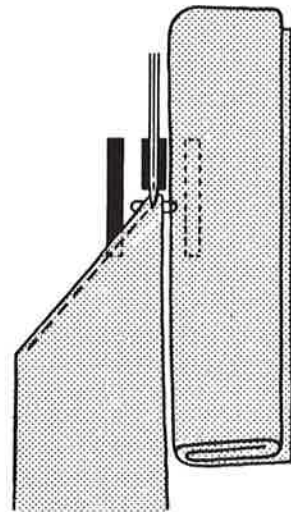

Presser feet
Practical stitches
Practical sewing

Presser feet

Presser feet are an important aid to sewing. They are designed with grooves and guides. The success of a piece of sewing is determined by the correct choice of presser foot.

0

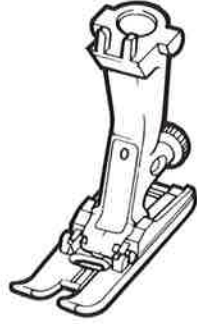

Zig-zag presser foot

Straight stitch
Zig-zag
Practical stitches

2

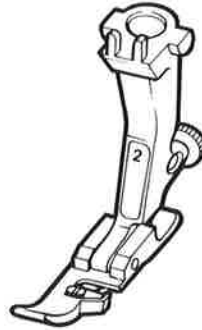

Overlock foot

Vari-overlock seam
Double overlock seam
Oversewing seam edges

3

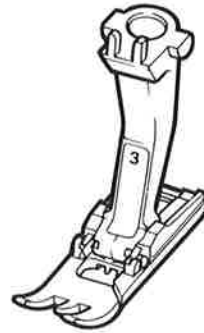

Buttonhole foot

Buttonholing

4

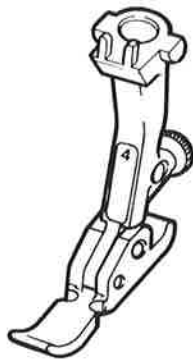

Zip foot

Sewing in zips
Piping

5

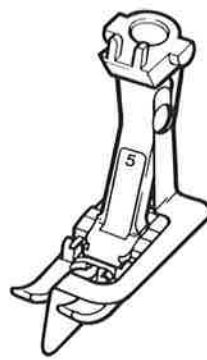

Blind stitch foot













Blind hemming
Edge stitching

6



Embroidery foot

Decorative stitching
Satin stitching
Applique
Couching

<p>1 Straight stitch</p>  <p>All types of non-elastic fabric</p> <p>All straight stitch work</p>	<p>2 Zig-zag stitch</p>  <p>For most types of fabric</p> <p>All simple zig-zag work, e.g. over-sewing, especially on fine fabrics. Sewing elastic and lace.</p>	<p>3 Sewn-out zig-zag</p>  <p>For most types of fabric</p> <p>Oversewing loosely woven fabrics, reinforcing and repairing edges, decorative work.</p>	<p>4 Blind stitch</p>  <p>For most types of fabric</p> <p>Blind hemming, shell edging on soft jersey and fine fabrics, decorative work.</p>
<p>5 Universal stitch</p>  <p>For firmer knitted fabrics, felt leather etc.</p> <p>Flat joining seams, visible hems, patchwork, mending interlock fabrics, sewing on elastic, decorative seams.</p>	<p>6 Lycra stitch</p>  <p>Especially for lycra fabric</p> <p>Flat joining seams and hems, re-sewing of seams in foundation garments.</p>	<p>7 Stretch stitch</p>  <p>For highly elastic fabrics</p> <p>Highly elastic open seams for ski, horse-riding, climbing and hiking wear.</p>	<p>8 Vari-overlock</p>  <p>Primarily for fine synthetic and silk jerseys, helanca and fine cotton and wool jerseys.</p> <p>Elastic overlock seams and hems, particularly suitable for sports underwear, pyjamas, T-shirts, sweat-shirts, jogging suits etc.</p>
<p>9 Running stitch</p>  <p>For most types of fabric</p> <p>Darning with running stitch, mending of woven fabric, reinforcing edges etc.</p>	<p>10 Scallop stitch</p>  <p>Primarily for woven fabrics</p> <p>Edging of tablecloths, place mats, collars, cuffs etc.</p>	<p>11-13 Decorative stitches</p> <p>11 </p> <p>12 </p> <p>13 </p>	

Straight stitch

Needle positions

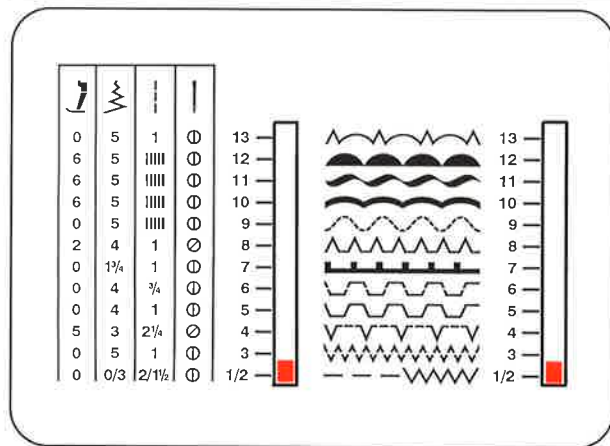

Presser foot:	0
Thread:	according to fabric
Needle:	according to thread
Stitch:	-----
Stitch width:	0
Stitch length:	1-5 according to fabric
Needle position:	centre
Feed-dog:	sewing

Forward sewing

The machine sews forwards with the settings specified and with the selected stitch length.

The stitch length is selected according to the type of sewing and fabric.

Reverse sewing

Push the stitch length knob upwards above 0 and hold until reverse sewing is completed.

When the knob is released, the machine will again sew forwards with the previously selected stitch.

Securing ends

At the beginning and end of a seam, sew in reverse for approx. 1 cm (3/8") and then forwards again.

Securing thick seams

When changing from forward to reverse sewing and vice-versa, stop the machine. The needle should be raised. If not, turn the handwheel forwards. This prevents the needle from being bent by thick fabrics.

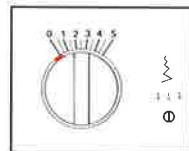
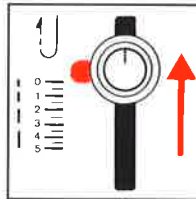

Stitch width
Needle position

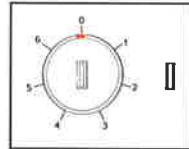

Buttonhole

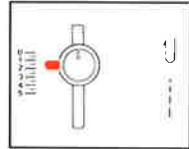

Stitch length
Normal stitch length is approx. 2

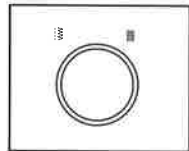

Feed-dog

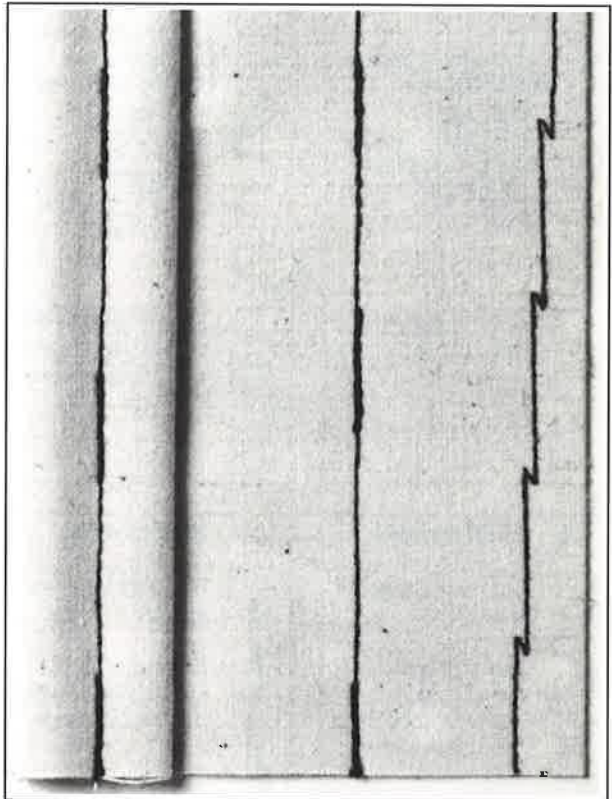

Five needle positions

The position of the stitch can be set to left and right in five positions with the needle position knob.

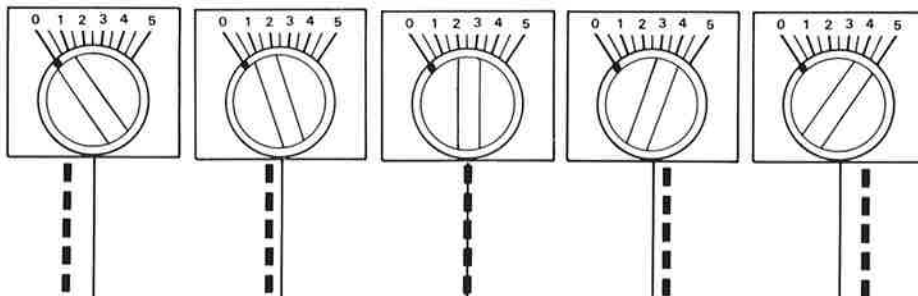

For normal sewing, the needle is in the centre.

Examples of use:

- Blind hemming Page 22
- Edge stitching Page 23
- Sewing in zips Page 19

Zig-zag

Satin stitch

Setting zig-zag

Presser foot:	0
Thread:	according to fabric
Needle:	according to thread
Stitch:	
Stitch width:	1-5
Stitch length:	1-5
Needle position:	centre
Feed-dog:	sewing

Setting zig-zag width and length

The stitch width and length can be altered during sewing or while the machine is stopped.

Set the width of the zig-zag stitch with the stitch width knob. It is infinitely variable up to 5 mm.

The needle must not be left in the work when the machine is stopped.

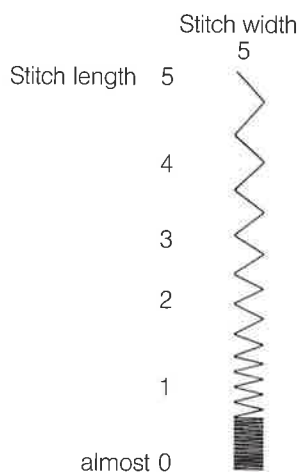

Satin stitch = close zig-zag = |||||

Presser foot:	6
Thread:	embroidery thread No. 30
Needle:	80
Stitch width:	1½-5
Stitch length:	(satin stitch density)

Set stitch length to very close zig-zag = |||||

Turn stitch length knob to the right until it locks.

The mark on the knob is at the top. Stitch length is now 0.

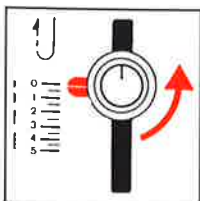

By rotating half a turn to the left (mark at the bottom) the basic setting for satin stitch is obtained = |||||.

Adjust the stitch density according to the work. Turn anti-clockwise for thicker fabric, clockwise for finer fabric.

Oversewing edges

Presser foot:	0
Thread:	darning or sewing thread
Needle:	80-70
Stitch width:	2½-5 (according to fabric)
Stitch length:	1-3 (according to fabric)

Generally, the zig-zag should not be too wide or the stitch length too long. Start by cutting a neat edge. Use as fine a thread as possible, especially on fine fabrics.

Guide the edge of the fabric to the centre of the foot so that the needle goes alternately into the fabric and then over the edge.

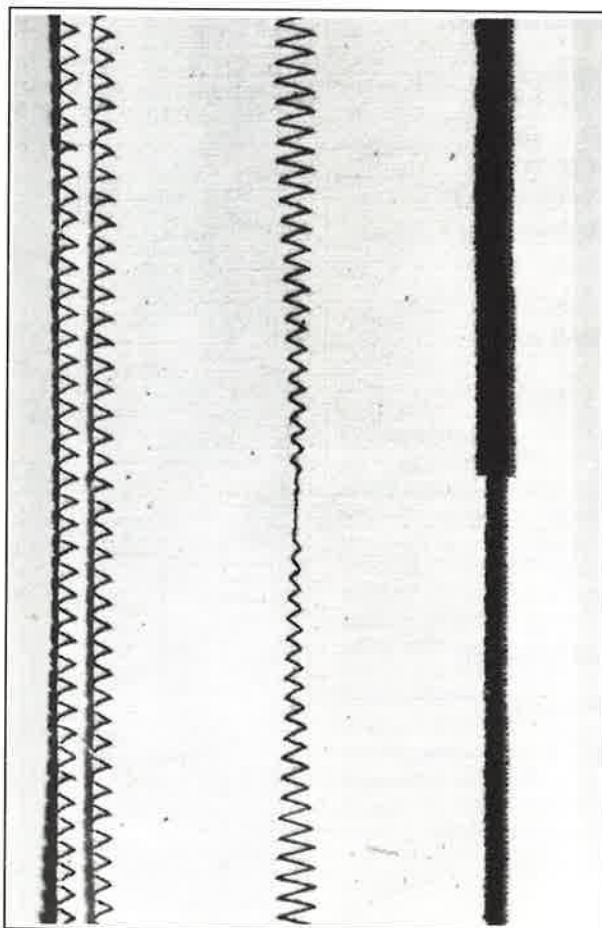
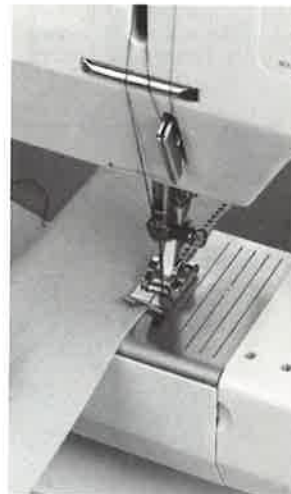

Selecting stitches

- a Presser foot
- b Stitch width
- c Stitch length
- d Needle position

Push the selector lever to the right to disengage and select a stitch from 1-13.

The number for the basic setting is the same as the number of the stitch selected.

Each stitch has many different applications. The stitch width and length can be adjusted to the type of work and fabric.

The presser foot display recommends the appropriate foot for easy work and perfect results.

Universal stitch

Presser foot:	0
Stitch:	
Stitch width:	4
Stitch length:	1
Needle position:	centre
Feed-dog:	sewing

Blind stitch

Presser foot:	5
Stitch:	
Stitch width:	3
Stitch length:	2 1/4
Needle position:	right
Feed-dog:	sewing

Vari-overlock

Presser foot:	2
Stitch:	
Stitch width:	4
Stitch length:	1
Needle position:	right
Feed-dog:	sewing

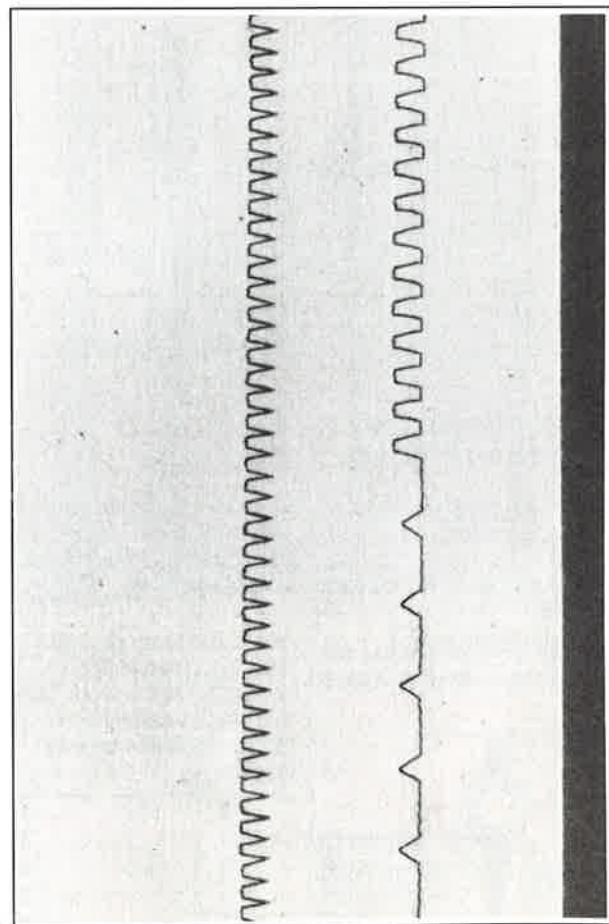

Sewing knitted fabrics

Zips

e.g. interlock, jersey

When sewing knitted fabrics, the following points generally apply:

1. Use a perfect needle. Even a very slightly blunt needle will damage the knit, causing it to ladder.
2. Use fine sewing thread, particularly for fine jerseys. Coarse thread can also damage the knit.
3. Use darning thread for basting. After the seam has been sewn, darning thread is more easily removed than the considerably thicker and shorter fibre basting thread.
4. Press each seam as it is sewn. This will make subsequent work easier.
5. Sew a sample to test the stretch of the stitch. The seam should be as stretchy as the fabric. As modern textiles vary considerably in their elasticity, the basic setting of the practical stitches can be adjusted where necessary to suit the fabric. Use a slightly longer stitch length for sewing knits.

Neckband with overlock seam

For all jerseys.

Presser foot:	2
Thread:	sewing thread
Needle:	80
Stitch:	
Stitch width:	4-5
Stitch length:	1
Needle position:	right
Feed-dog:	sewing

Fold the neatly cut neckband in half and press. Pin and baste to the right side of the neckline with the cut edges of the band exactly in line with the neckline edge. When sewing, guide the edges to the pin of the overlock foot.

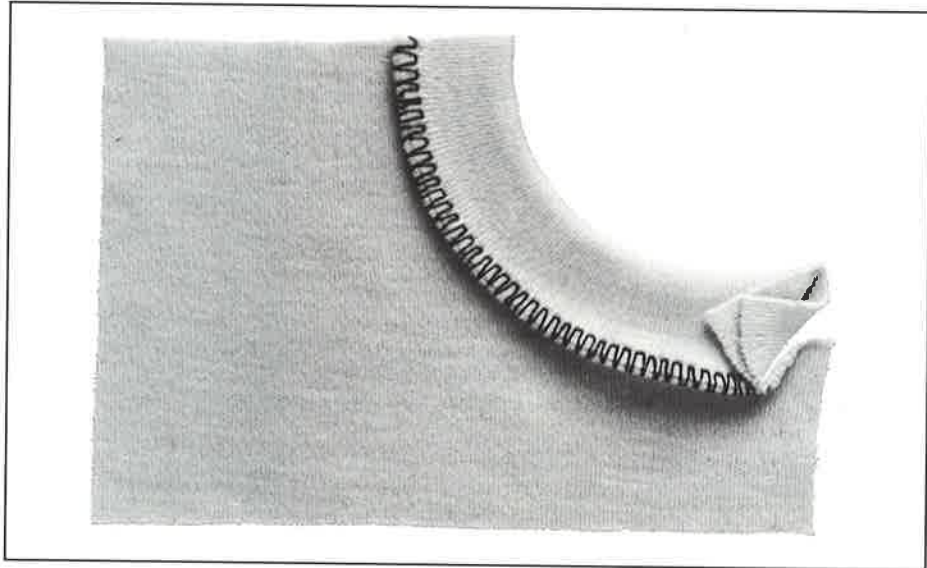

Sewing in zips

Zip fastener inserted flat

Presser foot:	4
Thread:	sewing thread
Needle:	80
Stitch:	
Stitch width:	0
Stitch length:	approx. 2
Needle position:	left/right
Feed-dog:	sewing

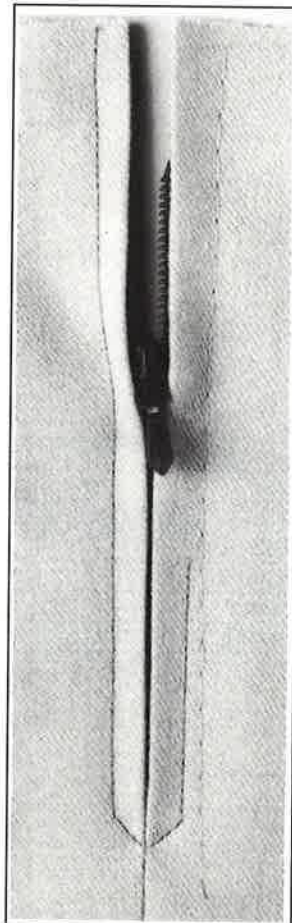

Preparation:

Baste entire length of seam. Mark length of zip and sew seam as far as the zip opening. Remove basting stitches, except in the zip section. Press the entire seam, trim and oversew. Remove remaining basting stitches. Baste the zip into position so that the teeth are covered by the fabric. Sew in the zip, starting each side at the bottom and sewing to the top, once with needle position right and once with needle position left.

Practical stitch seams

There are two types of seam:

Open seams

These are seams which are pressed open

- they lie flat and are not bulky
- they allow garments to be let out

Overlock seams

These are seams that are sewn and oversewn in one operation

- they are quick to sew
- they are narrow, but do not allow garments to be let out

Zig-zag seam

open seam

Stretchy seam for jersey fabrics in wool, synthetic or blended fibres, and for silk, cotton and wool interlock.

Suitable for sweaters, jackets and all hand and machine knitted garments.

Presser foot:	0
Thread:	sewing thread
Needle:	80
Stitch:	
Stitch width:	1
Stitch length:	1½
Needle position:	centre
Feed-dog:	sewing

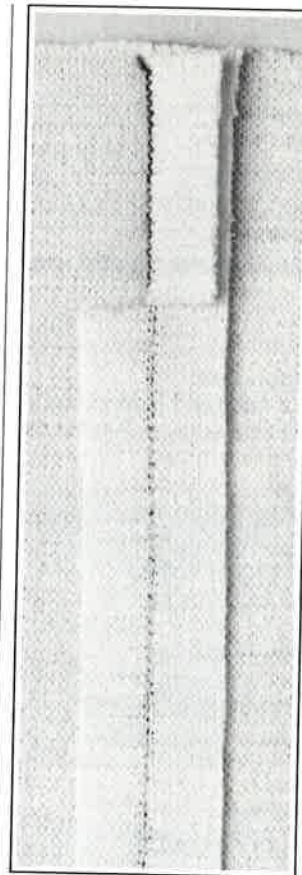

Zig-zag seam

Stretch seam

open seam

Very stretchy seam for stretch fabrics, especially for sportswear of all kinds.

Suitable also for lounge-wear and craft work.

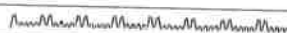
Presser foot:	0
Thread:	sewing thread
Needle:	80
Stitch:	
Stitch width:	1¾
Stitch length:	¾-1
Needle position:	centre
Feed-dog:	sewing

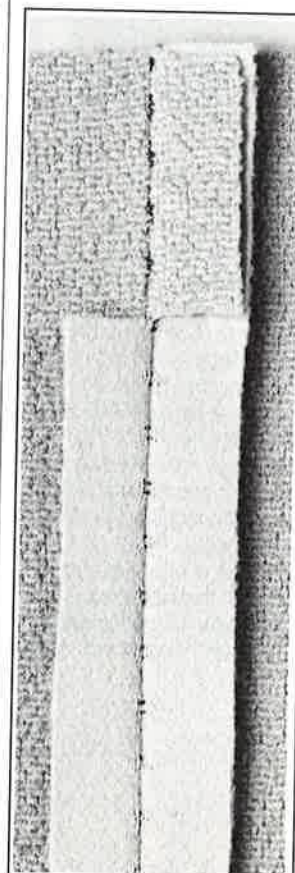

Stretch seam

Vari-overlock seam

Stretchy overlock seam for all fine jersey fabrics,

dresses, blouses, underwear, nightwear etc.

Presser foot:	2
Stitch:	
Stitch width:	4
Stitch length:	1
Needle position:	right
Feed-dog:	sewing

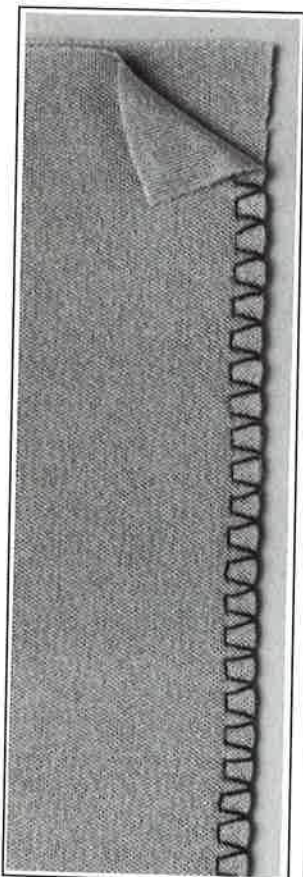

Vari-overlock seam

Reminder:

For sewing knitted fabrics see Page 19.

Blind hemming

Presser foot:	5
Thread:	sewing/darning thread
Needle:	80-70
Stitch:	
Stitch width:	approx. 3
Stitch length:	2¼
Needle position:	right/half right
Feed-dog:	sewing

Sewing table/special accessory

Important

As with hand sewing, fine fabrics require a fine needle and fine thread.

Preparation

The hem should be prepared in the same way as for sewing by hand. Oversew raw edge, baste and press.

Positioning the hem

The hem is positioned under the foot as shown in Fig. 1.

Sewing test

(Either on a remnant of fabric or directly on the hem.)

Given the variations in fabric thickness, it is advisable to sew a test piece first. As when sewing by hand, the needle should only catch the fold of the fabric. Because of these variations, a slight adjustment may be necessary.

Sew slowly until the needle swings to the left. Using the handwheel, bring the needle down until it is just about to enter the fabric and check that it is only just catching the fabric. If necessary, adjust the stitch width slightly.

Narrower if the needle is going in too far and a little wider if it is failing to catch sufficiently.

Check the next zig-zag stitch in the same way. Then sew for approximately 10 cm (4") and check again.

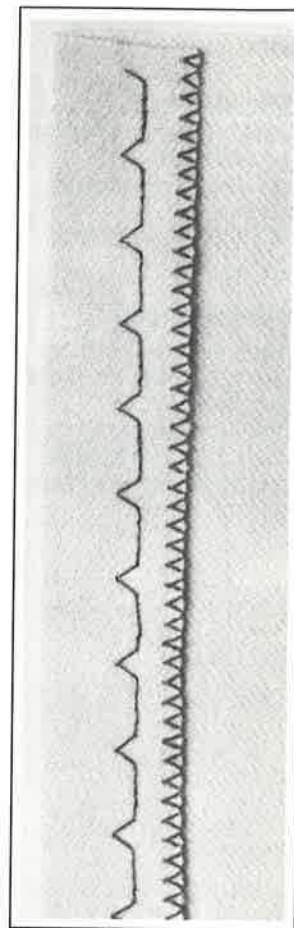
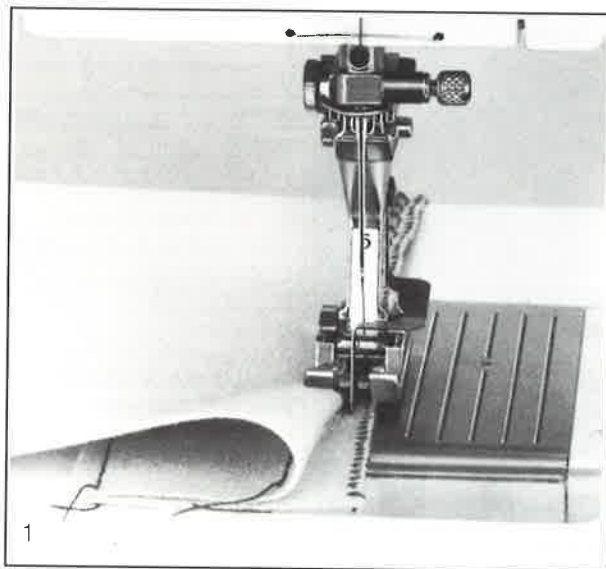

Guiding the work

In this way, you can check that the hem is running straight.

Tip: While sewing, hold the underfabric back slightly (Fig. 2).

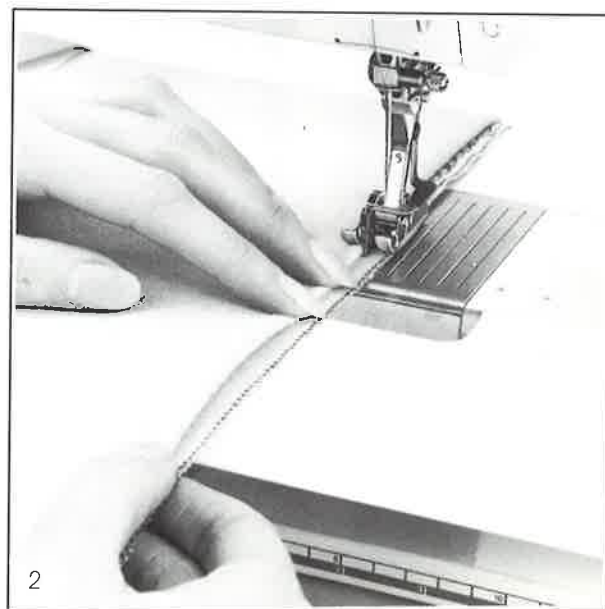

Edge stitching using the needle positions

Edge stitching on collars, cuffs, lapels, hems, etc.

Presser foot:	5
Thread:	sewing thread
Needle:	80
Stitch:	-----
Stitch width:	0
Stitch length:	2-5 (as required)
Needle position:	left/half left
Feed-dog:	sewing

Sewing table/additional accessory

Place the edge of the fabric from the left against the guide of the Blind stitch foot (Fig. 1). Set the needle position to left or half left.

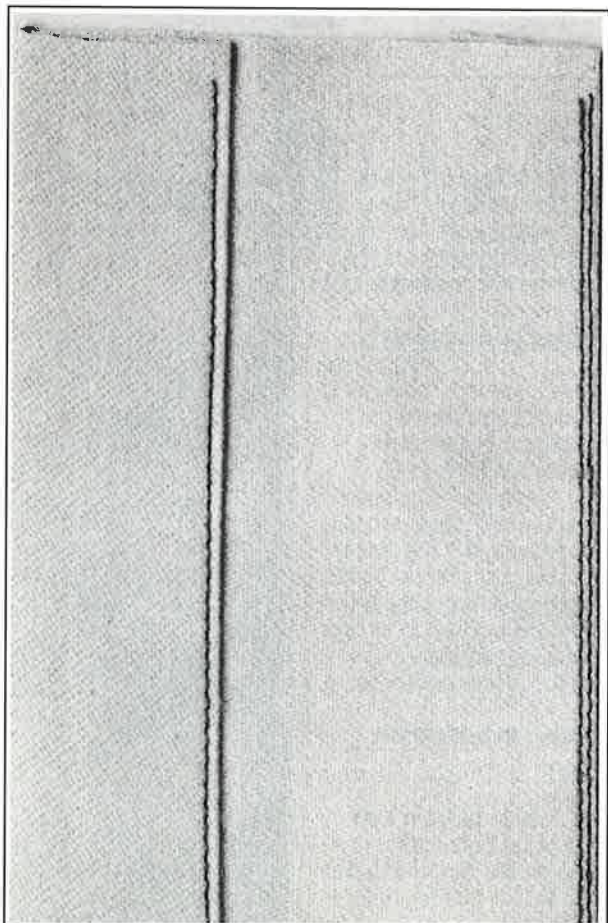
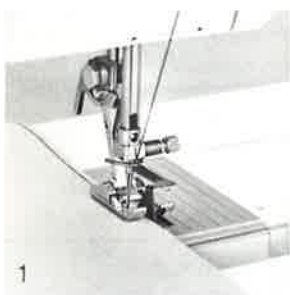

Top stitching, for edges of all kinds.

Presser foot:	0
Thread:	sewing thread
Needle:	80
Stitch:	-----
Stitch width:	0
Stitch length:	2-5 (as required)
Needle position:	any position
Feed-dog:	sewing

Guide the edge of the fabric to the edge of the presser foot or along the grooves in the stitch plate.

Widths:

Needle position centre)

Edge of presser foot = 7.5 mm ($\frac{5}{16}$ "'). (Fig. 2)

Grooves in stitch plate:

Line 1 = 1 cm ($\frac{3}{8}$ "')

Line 2 = 1.5 cm ($\frac{5}{8}$ "')

Line 3 = 2 cm ($\frac{3}{4}$ "')

Line 4 = 2.5 cm (1"') (Fig. 3)

Line 5 = 3 cm ($1\frac{3}{16}$ "')

It is also possible to sew intermediate widths using the left, half left, right and half right needle positions.

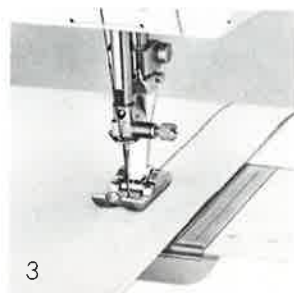
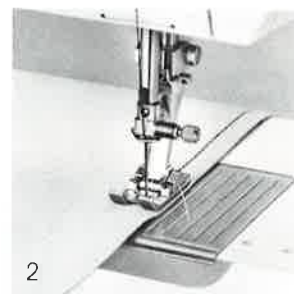

Buttonhole

Presser foot:	3
Thread:	sewing/darning thread
Needle:	80-70
Stitch:	
Stitch width:	set automatically
Stitch length:	IIII (satin stitch)
Needle position:	set automatically
Feed-dog:	sewing

To sew buttonholes, thread the lower thread through the finger of the bobbin case (Fig. 1).



1

Setting buttonhole

1. Switch buttonhole knob to position 1 (Fig. 2).

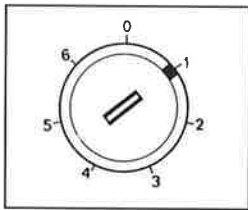

2

2. Set stitch length: Turn knob to the right until it locks. The mark will be at the top (Fig. 3). Stitch length is 0. By rotating half a turn to the left (mark at the bottom) the basic stitch

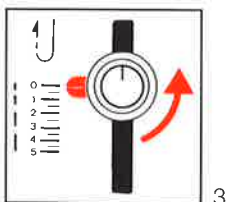

3

length setting for buttonholes is obtained = IIIII.

Set the stitch density according to the fabric. Turn anticlockwise for thicker fabrics, clockwise for finer fabrics.

Always sew a trial buttonhole.

The stitch length will vary slightly depending on the fabric.

Sewing the buttonhole

Lay the fabric under the foot so that the edge of the fabric lies in front of the presser foot (Fig. 4). Lower the needle with the aid of the handwheel and

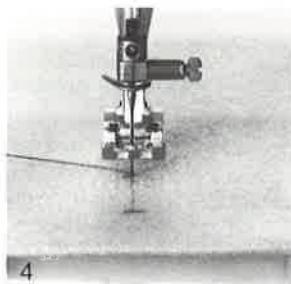

4

check that it is in the **centre** of the presser foot. If not, turn the handwheel. Lower the needle into the fabric precisely at the start of the buttonhole. Lower the presser foot and sew the buttonhole in steps.

Note: After each step, raise the needle by turning the handwheel forward.

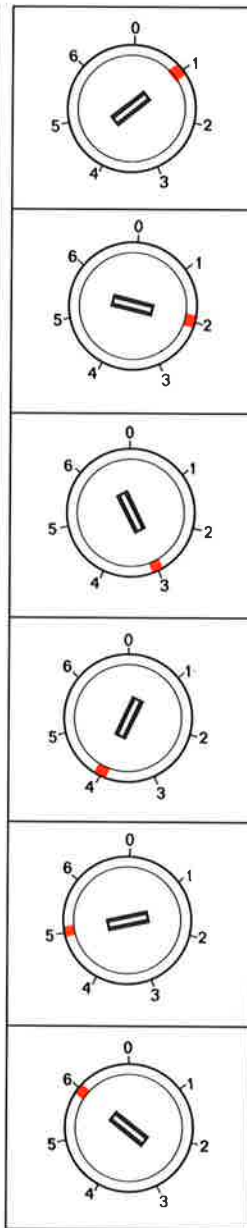

Knob to 1
Machine sews the first bead forwards.

Knob to 2
Machine sews a reverse straight stitch.

Knob to 3
Machine sews the bar tack.

Knob to 4
Machine sews the 2nd bead forwards.

Knob to 5
Machine sews the bar tack.

Knob to 6
Machine sews securing stitches.

Further buttonholes

Reset knob to 1. The sewing sequence continues as described. For all other sewing, set knob to 0.

Cutting the buttonhole open

It is best to cut from each end of the buttonhole towards the centre (Fig. 5). This avoids cutting through a bar tack.



5

With gimp cord

Buttonhole with gimp cord

The gimp cord strengthens the buttonhole.

The gimp cord is especially important for all knitted fabrics – including hand and machine knits – to prevent the buttonhole from pulling out of shape.

The thickness of the cord depends on the fabric to be sewn. Suitable cords are: perle cord no. 8, thick hand sewing thread or fine crochet cord. Sew a trial buttonhole.

Lay the fabric under the foot so that the folded edge or seam lies in front of the presser foot. The loop of the gimp will lie at the end of the buttonhole where the button will pull (Fig. 1).

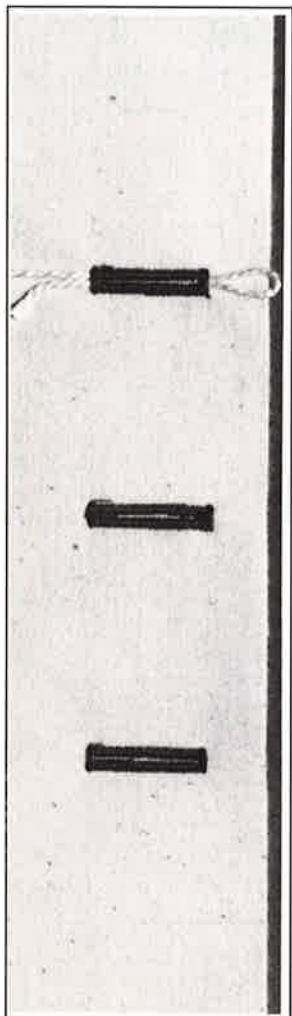

Sewing with gimp cord

It is easier to position the cord if the needle is already in the fabric:

1. Using the handwheel, lower the needle and check that it is in the centre of the presser foot. If not, turn the handwheel. Lower the needle into the fabric precisely at the start of the buttonhole. Do not lower the foot yet.

2. Hook the gimp cord over the centre prong of the buttonhole foot and take both ends back under the foot (Fig. 2). Lower the foot and check that the cord is able to slide, i.e. is not trapped by the foot.

3. Sew the buttonhole. At position 2 (reverse straight stitch), the cord comes away from the prong of the foot. Therefore, it is advisable to hold the loop of gimp down LIGHTLY with the finger (Fig. 3).

Finally, pull the loop of gimp through. With knitted fabrics, pull the gimp ends to the rear with a coarse hand sewing needle (Fig. 4) and tie or sew in securely. In woven fabrics, the gimp ends can be simply cut off.

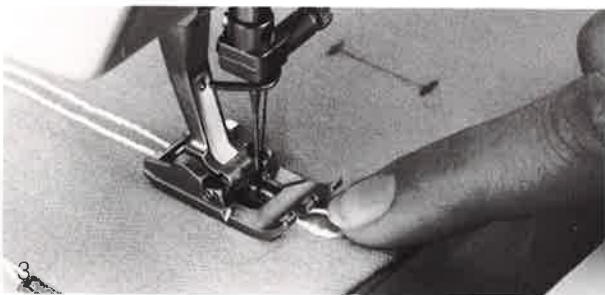
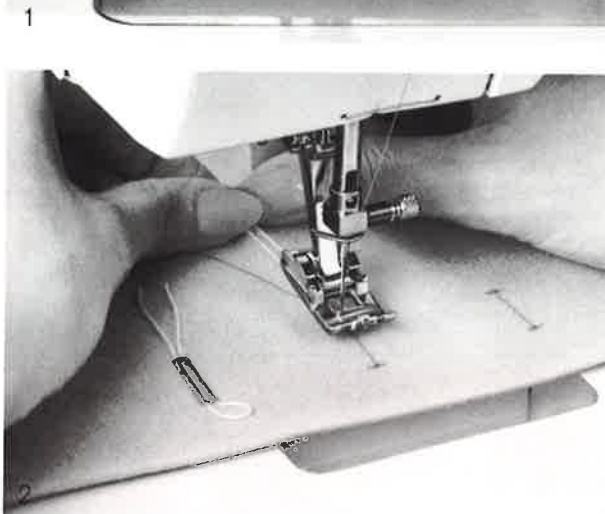
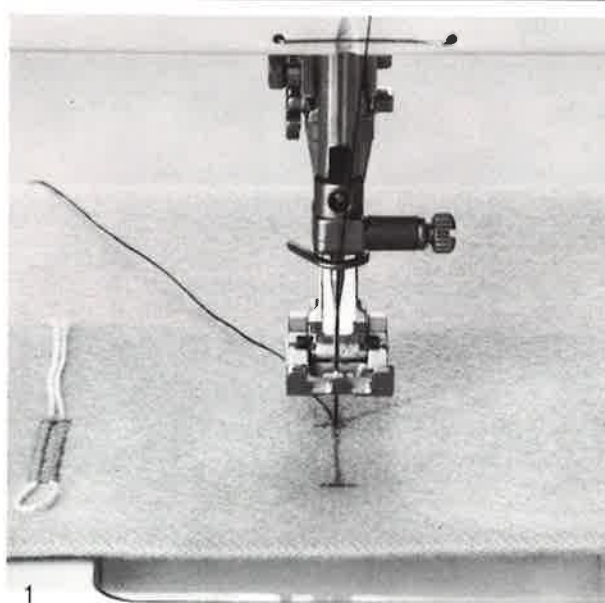

Mending interlock fabric

Patching

Presser foot:	0
Stitch:	
Stitch width:	3-4
Stitch length:	approx. 1-1½
Needle position:	centre
Feed-dog:	sewing

Can also be sewn with the Universal stitch.

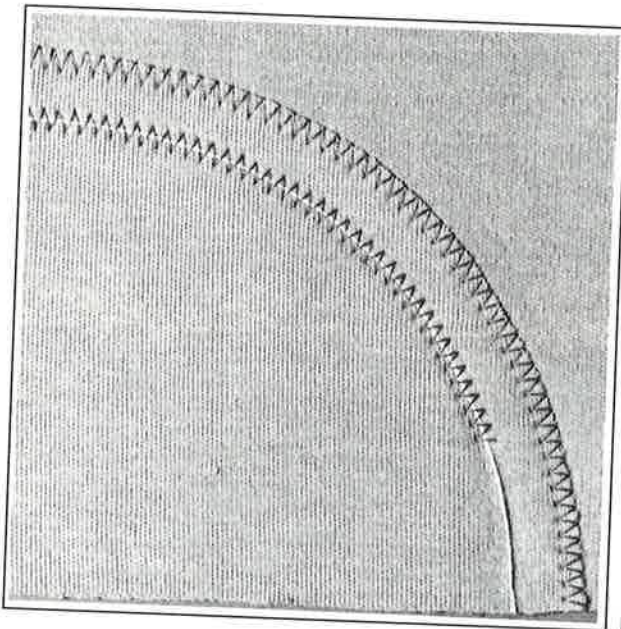

Cut out a patch, if possible from the sound part of a discarded similar garment. Where possible, round off the corners to preserve the elasticity in all directions. Pin on the patch and baste as close as possible to the edge. Then sew with 1-2 rows of zig-zag stitch, possibly sewing in thread simultaneously.

Finally, cut away torn/worn piece from behind patch.

For all knits, refer to the general instructions "Sewing knitted fabrics" on page 19.

Mending woven fabric

Mending tears using

Running stitch

(Modern darning method) for tears and thin areas on virtually all fabrics.

Presser foot:	0
Thread:	darning thread/Machine emb. 60
Needle:	80-70
Stitch:	
Stitch width:	5
Stitch length:	
Needle position:	centre
Feed-dog:	sewing

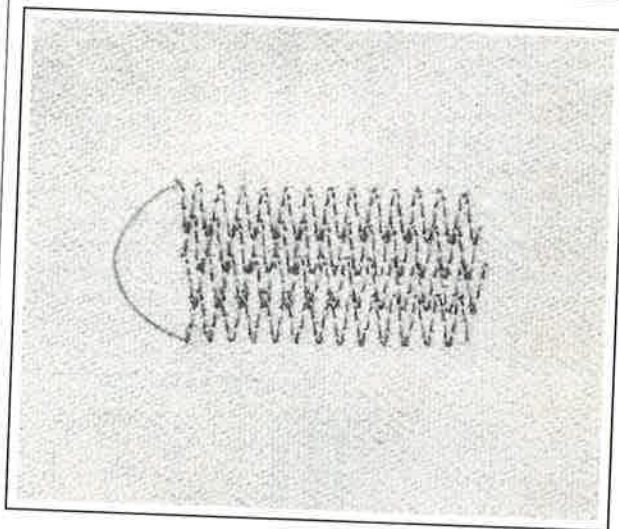

Always lay a fine fabric underneath. On tears, sew 3-5 rows of Running stitch, depending on the type of fabric (Fig. 1). On thin areas, sew sufficient adjacent rows to cover. Let each row overlap the previous one very slightly.

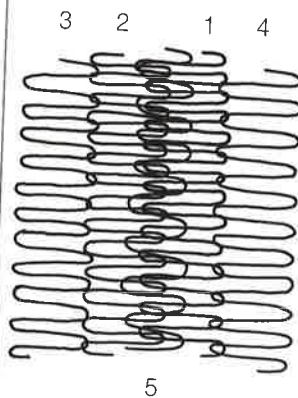



Troubleshooting Maintenance

Fault prevention

If the sewing machine does not sew properly, it is usually due to incorrect use.

Check whether:

- The upper and lower threads are correctly threaded;
- The needle has been correctly inserted with the flat side of the shank to the rear.
- The needle size is correct. See needle and thread table.
- The machine is clean. Brush away any thread remnants.
- The hook race is clean and lubricated.
- Any remnants of thread are trapped between the thread tension disc and beneath the bobbin case spring.

Upper thread breaks

- The upper thread tension is too tight.
- Poor quality needles. Ideally, needles should be purchased from a BERNINA dealer.
- The needle has been incorrectly inserted. The flat side of the shank must be to the rear.
- The needle is blunt or bent.
- Poor quality thread, knotted or dried-out thread.
- Stitch plate or hook tip damaged. Take to a BERNINA dealer.

Lower thread breaks

- The lower thread tension is too tight.
- The bobbin is jamming in the bobbin case. Replace bobbin.
- The hole in the stitch plate has been damaged by the needle. This must be repolished by an expert.
- The needle is blunt or bent.

Skipped stitches

- Wrong needles. Use only 130/705H needle system.
- The needle is blunt, bent or incorrectly inserted. Push right to the top when inserting.
- Poor quality, badly polished needle.
- The needle point does not suit the fabric being sewn. If necessary, use ball point for knitted fabrics and cutting point for leather.

Needle breaks

- Needle clamp screw not sufficiently tightened.
- Fabric withdrawn forwards instead of backwards under the presser foot.
- When sewing over a thick area, the fabric was pushed while needle still in the fabric.
- Poor quality thread, unevenly wound or knotted.

Faults in seams

- Remnants of thread between the thread tension discs.
- Remnants of thread under the bobbin case spring.
- Lower thread still threaded in the bobbin case finger.
- Threaded with foot down.
- Incorrectly threaded. Check lower and upper threads.

Machine fails to run

- Plug is not inserted properly.
- Power switch in 0 position.
- Machine gummed up by use of unsuitable oil. Machine will have to be cleaned by a BERNINA dealer.
- Machine has been standing in a cold room.

Important

If you have to take your machine to a BERNINA dealer, please always take the foot control unit and accessories.

Changing the bulb



WARNING:

Please refer to the safety instructions.

Sewing light:
220V/15 Watt

Changing the bulb

Disconnect the machine from the mains – take the plug out of socket.
Using the special bulb holder, press the bulb up, twist to the left and remove.

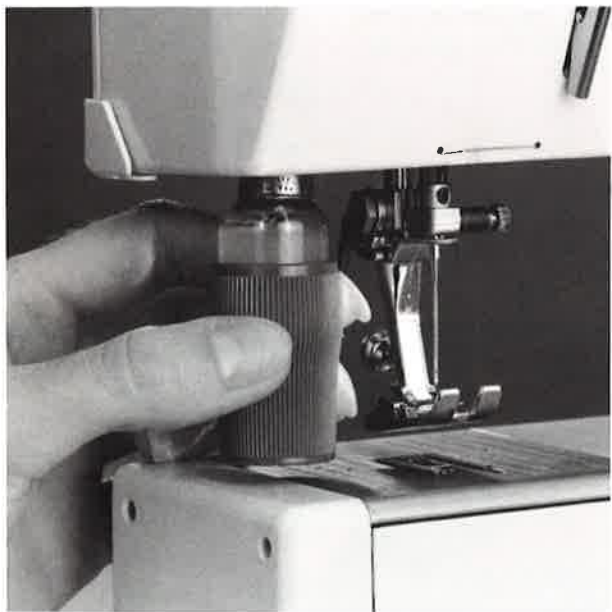

To insert new bulb:
Place the new bulb on the bulb holder.
Insert the bulb into the socket, press upwards and twist to the right as far as it will go.

Maintenance: Cleaning and oiling

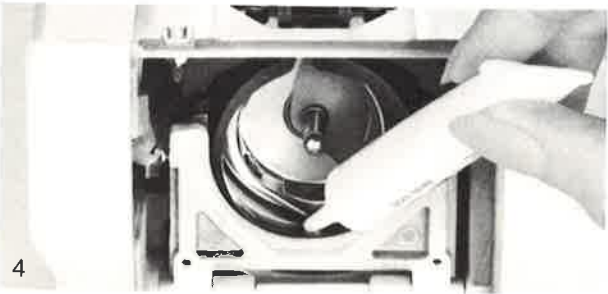
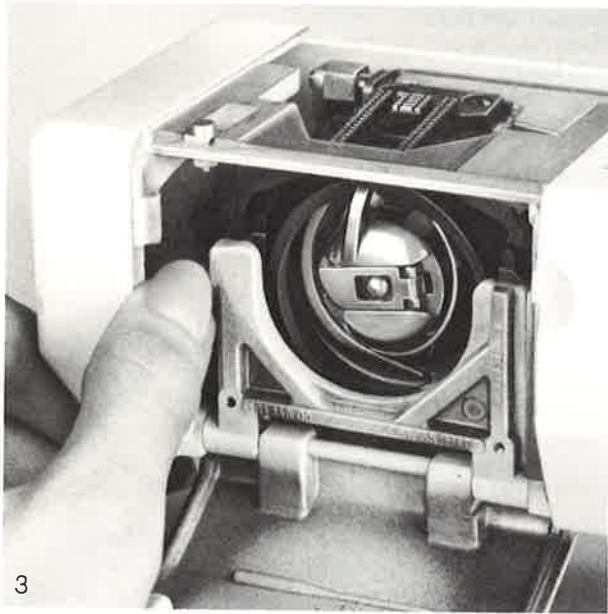
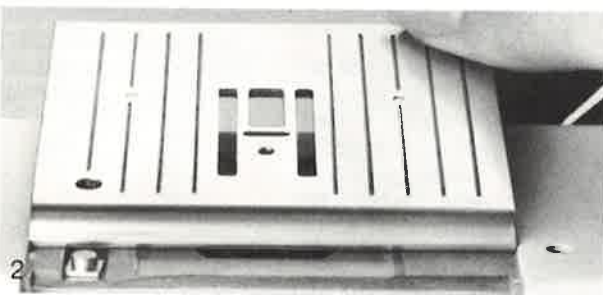
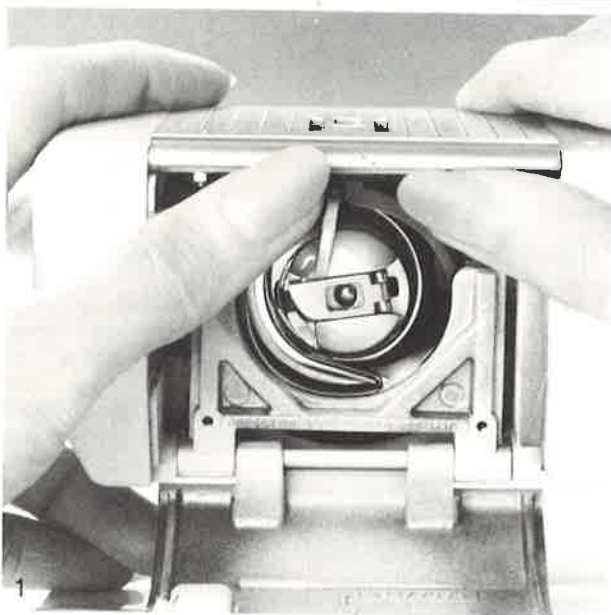

If the machine is stored in a cold room, it should be brought to a warm room approximately one hour before use, to restore the oil in the bearings to a fluid state.

Cleaning

During sewing, fluff from the thread will collect under the stitch plate and around the hook. These remnants must be removed from time to time.

Disconnect the machine from the mains by removing the mains plug from the socket!

- Remove the presser foot and needle.
 - Open the hinged front cover on the free arm.
 - Lower the feed-dog. Set knob to position .
- Using both thumbs, press the stitch plate up and back (Fig. 1).
- Clean the feed-dog and underside of the stitch plate.
 - To refit the stitch plate on the free arm, insert the stitch plate from the rear, push forward until it engages (Fig. 2).

WARNING:

Please refer to the safety instructions.

To oil the hook:
Apply 1–2 drops of oil after 3–4 hours' sewing.

To clean and oil the hook

Disconnect the machine from the mains by removing the mains plug from the socket!

- Take out the bobbin case, see page 4.
- With the thumb of the left hand, press the lower release lever to the left (Fig. 3).
- Fold down the semi-spherical locking strap with the black hook race cover.
- Take out the hook.
- Clean the top and bottom of the hook race with the cleaning brush and cotton cloth. Never use a screw-driver, scissors etc. to remove remnants of thread.
- Lightly oil the hook race with 1–2 drops of oil (Fig. 4). Insert the hook. If necessary, turn the hand-wheel until the hook driver is on the left (Fig. 5).
- Close the black hook race cover and locking strap. The pawl must engage.
- Check by turning the handwheel.
- Insert the bobbin case.

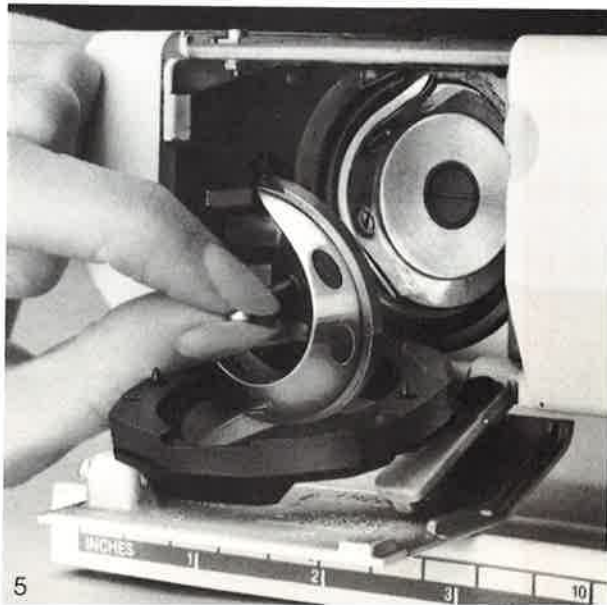



**Bernina
Publications**

BERNINA publications

It is not possible to cover more than the basics of sewing in an instruction manual. However, the creative potential of your BERNINA sewing machine and BERNETTE overlocker is enormous. To help you use your machines to the full, BERNINA regularly publishes sewing literature which covers everything from simple techniques to advanced fashion projects. Your BERNINA Dealer will be delighted to give you more information.

Sewing Service Leaflets

Each issue of our Sewing Service Leaflets deals with a particular sewing technique presented in easy to follow steps. Success is guaranteed!

BERNINA Creative Sewing

The BERNINA Creative Sewing magazine appears twice yearly. Fashion, "Couture Rapide", home decoration, sewing for teens and twens and craft projects are all regular features of the magazine. Special sewing techniques which are featured in the sewing projects are described in detail in words and pictures. Unusual and imaginative ideas are also included from enthusiastic sewers around the world. Read about new sewing developments and trends in the comfort of your own home. The Creative Sewing magazine is a source of inspiration for all sewers. Ask your BERNINA Dealer and learn how to get the most out of your machines.

BERNINA Collection

These booklets deal with one particular theme in all its variations. Basic information, pattern suggestions, detailed sewing instructions with coloured illustrations and many tips and tricks of the trade will turn you into a sewing pro in no time at all. They are issued two to three times a year, so be sure to ask your BERNINA Dealer when the next one is expected.



Index

Index

A		F		P		T	
Accessories		Fault prevention	28	Presser feet	14	Thick seams	16
– standard	2	Faulty seams	28	– Blind stitch foot	14	Thread cutter	7,9
Accessories box		Feed-dog		– Buttonhole foot	14	Thread/needle table	10
– removing	2	– and fabric feed	11	– changing	8	Thread tension	7
– attaching	2	– and sewing corners	11	– Embroidery foot	14	Threading	
		– and stitch length	11	– Overlock foot	14	– upper thread	6
		– lowering	7	– Zig-zag presser foot	14		
B		Foot control unit		– Zip foot	14		
Blind hemming	22	– attaching	3	Publications	31		
Blind hem stitch	15	Forwards sewing	16			U	
Bobbin				R		Universal stitch	15
– inserting	5	H		Replacing		Upper thread	
– winding	4	Hems		– bulb	29	– breaks	28
Bobbin case and bobbin		– with practical stitches	20	– needles	8	– threading	6
– inserting	5	– universal stitch	20	Reverse sewing	16		
– removing	4	– vari-overlock	20	Running stitch	15	V	
Bulb						Vari-overlock stitch	15
– changing	29	L		S			
Buttonhole	24	Lower thread		Satin stitch	17	Z	
– with gimp cord	25	– breaks	28	Scallop stitch	15	Zig-zag	15, 17
		– bringing up	7	Securing ends	16	– adjusting	17
C		– winding bobbin	4	Seams with		– oversewing edges	17
Cleaning and		Lubricating/cleaning	30	– practical stitches	21	– satin stitch	17
lubricating	30			Selecting stitches	18	Zips	19
Cover	2	M		Sewing knitted fabrics	19		
		Machine cable		– neckband with			
D		– attaching	3	overlock stitch	19		
Decorative stitches	15	Machine does not run	30	Sewing light	3		
Double overlock stitch	15	Maintenance	30	Sewing tips	9		
		Mending		Special needles	10		
E		– interlock	26	Standard accessories	2		
Edge stitch	15	Mending woven fabrics		Straight stitch	15, 16		
Edge stitching	23	– with Running stitch	26	– forwards sewing	16		
– top stitching	23			– reverse sewing	16		
– using				– securing ends	16		
needle positions	23			– thick seams	16		
				Stretch stitch	15		
				Supplementary			
				thread guide	6		

WARNING:

Before using your sewing machine, please read the Safety Instructions.

Sollte diese Maschine in ein anderes Sprachgebiet verkauft werden, fordern Sie beim nationalen Importeur oder BERNINA Händler eine Bedienungsanleitung in der entsprechenden Sprache an.

If this machine has been purchased in a foreign country, please request an instruction manual in your own language from the national Importer or a BERNINA dealer.

Si cette machine est vendue dans une autre région linguistique, demandez à l'importateur national ou à l'agent BERNINA, un manuel d'instructions dans la langue correspondante.

In caso questa macchina fosse venduta in un territorio di lingua diversa si prega di richiedere il libretto d'istruzione nella lingua adeguata presso l'importatore nazionale oppure presso un rivenditore BERNINA.

Si esta máquina se vende en otra región lingüística entonces pida Vd. de su importador nacional o del representante BERNINA un manual de instrucciones en el idioma correspondiente.

Indien deze machine in een ander taalgebied werd gekocht, kunt u bij de nationale importeur of BERNINA vakhandelaar een handleiding in de overeenkomstige taal aanvragen.

Skulle denne maskine blive solgt i et andet sprogområde, bedes du henvende dig hos den nationale BERNINA-importør eller en BERNINA-forhandler, hvor du kan købe en brugsanvisning på det ønskede sprog.

Om den här maskinen har köpts i ett annat land, var vänlig beställ en instruktionsbok på Ditt eget språk från importören eller en BERNINAN-återförsäljare.

Er denne maskinen kjøpt i utlandet, kan instruksjonsbok bestilles på ditt eget språk fra BERNINA importøren eller nærmeste BERNINA forhandler.

Tarvittaessa voit tiedustella omakielistäsi käyttöohjekirjaa BERNINA-maahantuojalta tai jälleenmyyjältä.

Se esta máquina foi comprada num país estrangeiro, dever-se-à pedir o manual de instruções naquela lingua ao importador nacional ou ao forneoedor da BERNINA.

Αν η μηχανή έχει αγοραστεί σε μια ξένη χώρα, παρακαλώ ζητήστε έναν οδηγό λειτουργίας στην δική σας γλώσσα από τον γενικό αντιπρόσωπο της BERNINA ή από τους πωλητές της BERNINA.

BERNINA®

© Copyright 1992 by Fritz Gegauf AG, Steckborn

92/06 GB 001.619.50.04 888