



See appendix for differences in the  
**activa 135 Patchwork Edition**



"Welcome to  
the BERNINA  
family"

H.P. Ueltschi  
Owner BERNINA  
Sewing Machine Company

# BERNINA®

In choosing **BERNINA**, you are assured of **years of rewarding sewing**. For over 100 years my family has concentrated on providing complete satisfaction to our customers. And it is my personal wish to continue this tradition of offering you Swiss precision engineering combined with state of the art technology and an after sales service second to none.

The new **BERNINA activa 135 and 145** are characterized by a youthful appeal which is combined with a range of added value features to give you, dear Customer, **more sewing pleasure** than ever before.

Enjoy modern, creative sewing with BERNINA: our wide range of accessories as well as our **sewing publications** brimming with imaginative ideas and practical tips all add to the joy of sewing BERNINA style.

Any questions you have will be dealt with courteously and efficiently by our highly trained **BERNINA dealers**, who will also be glad to service your sewing computer for you.

Fritz Gegauf Ltd. • BERNINA Sewing Machines • CH-8266 Steckborn/Switzerland

---

# IMPORTANT SAFETY INSTRUCTIONS

When using an electrical machine, basic safety precautions should always be followed, including the following.

Read all instructions before using this sewing computer.

**When the sewing computer is not in use, it should be disconnected from the electricity supply by removing the plug from the outlet.**

## DANGER



**To reduce the risk of electric shock:**

1. A sewing computer should never be left unattended when plugged in.
2. Always unplug the sewing computer from the electric outlet immediately after using and before cleaning.
3. Always unplug before replacing light bulb. Replace the bulb with the same type rated 12 volts/5 watts.

## WARNING



**To reduce the risk of burns, fire, electric shock or injury to persons:**

1. Do not allow to be used as a toy.  
Close attention is necessary when the sewing computer is used by or near children and infirm persons.
2. Use this sewing computer only for its intended use as described in this manual. Use only attachments recommended by the manufacturer as contained in this manual.
3. Never operate this sewing computer if
  - it has a damaged cord or plug
  - it is not working properly
  - it has been dropped or damaged
  - it has fallen into waterReturn the sewing computer to the nearest authorized **BERNINA** dealer or service center for examination, repair, electrical or mechanical adjustment.

4. Never operate the computer with any air openings blocked. Keep ventilation openings of the sewing computer and foot control free from accumulation of lint, dust and loose cloth.
5. Keep fingers away from all moving parts. Special care is required around the sewing needle.
6. Always use the BERNINA original needle plate. The wrong plate can cause the needle to break.
7. Do not use bent needles.
8. Do not pull or push fabric while stitching. It may deflect the needle causing it to break.
9. Turn power switch to «0» when making any adjustments in the needle area, such as threading or changing the needle, threading the bobbin or changing the presser foot.
10. Always unplug the sewing computer from the electrical outlet when removing covers, lubricating or when making any other user servicing adjustments mentioned in this instruction manual.
11. Never drop or insert any object into any opening.
12. Do not use outdoors.
13. Do not operate where aerosol (spray) products are being used or where oxygen is being administered.
14. Before disconnecting, turn all controls to the off («0») position then remove the plug from the outlet.
15. Do not unplug by pulling on the cord but grasp the plug.
16. No responsibility will be taken for any possible damage as the result of misuse of the sewing computer.

**This sewing computer is intended for household use only.**



**SAVE THESE INSTRUCTIONS!**

## Details of the sewing computer

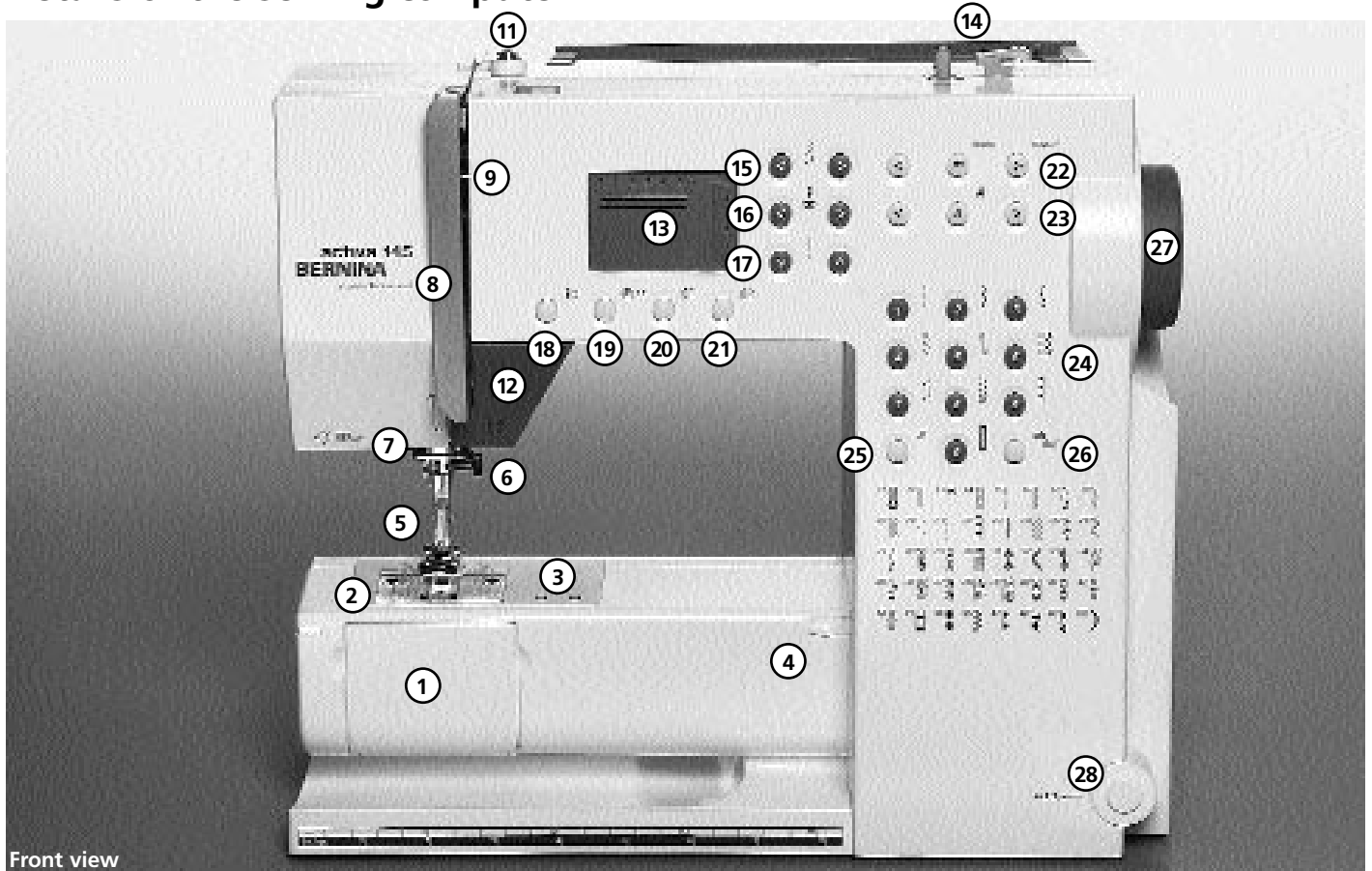

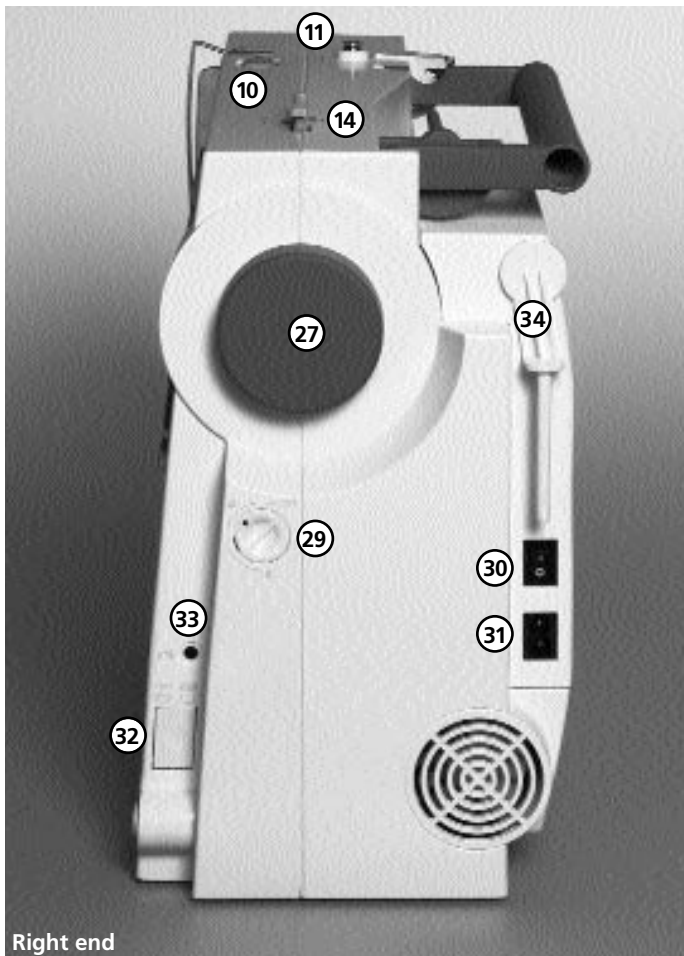

Right end

- |    |  |    |                                   |
|----|--|----|-----------------------------------|
| 1  | Bobbin cover                                       | 24 | Stitch selection buttons          |
| 2  | Stitch plate                                       | 25 | #-button                          |
| 3  | Attachment base for special accessories            | 26 | clr/del-button                    |
| 4  | Sewing table socket                                | 27 | Handwheel                         |
| 5  | Presser foot                                       | 28 | FHS connection                    |
| 6  | Needle clamp with fixation screw                   | 29 | Balance adjustment knob           |
| 7  | Thread guide                                       | 30 | Power switch on/off               |
| 8  | Thread take up cover                               | 31 | Power plug socket                 |
| 9  | Thread path  | 32 | Drop feed-dog                     |
| 10 | Thread tension adjustment                          | 33 | Foot control socket               |
| 11 | Bobbin pre-tension                                 | 34 | Spool pin (vertical, collapsible) |
| 12 | Reverse button/quick and continuous                |    |                                   |
| 13 | Screen   |    |                                   |
| 14 | Bobbin winder with on/off switch and thread cutter |    |                                   |
| 15 | Stitch width button                                |    |                                   |
| 16 | Needle position button                             |    |                                   |
| 17 | Stitch length button                               |    |                                   |
| 18 | Needle stop up/down                                |    |                                   |
| 19 | 1/2 speed  |    |                                   |
| 20 | Pattern end  |    |                                   |
| 21 | Mirror image                                       |    |                                   |
| 22 | mem (memory) button                                |    |                                   |
| 23 | Alphabet buttons                                   |    |                                   |

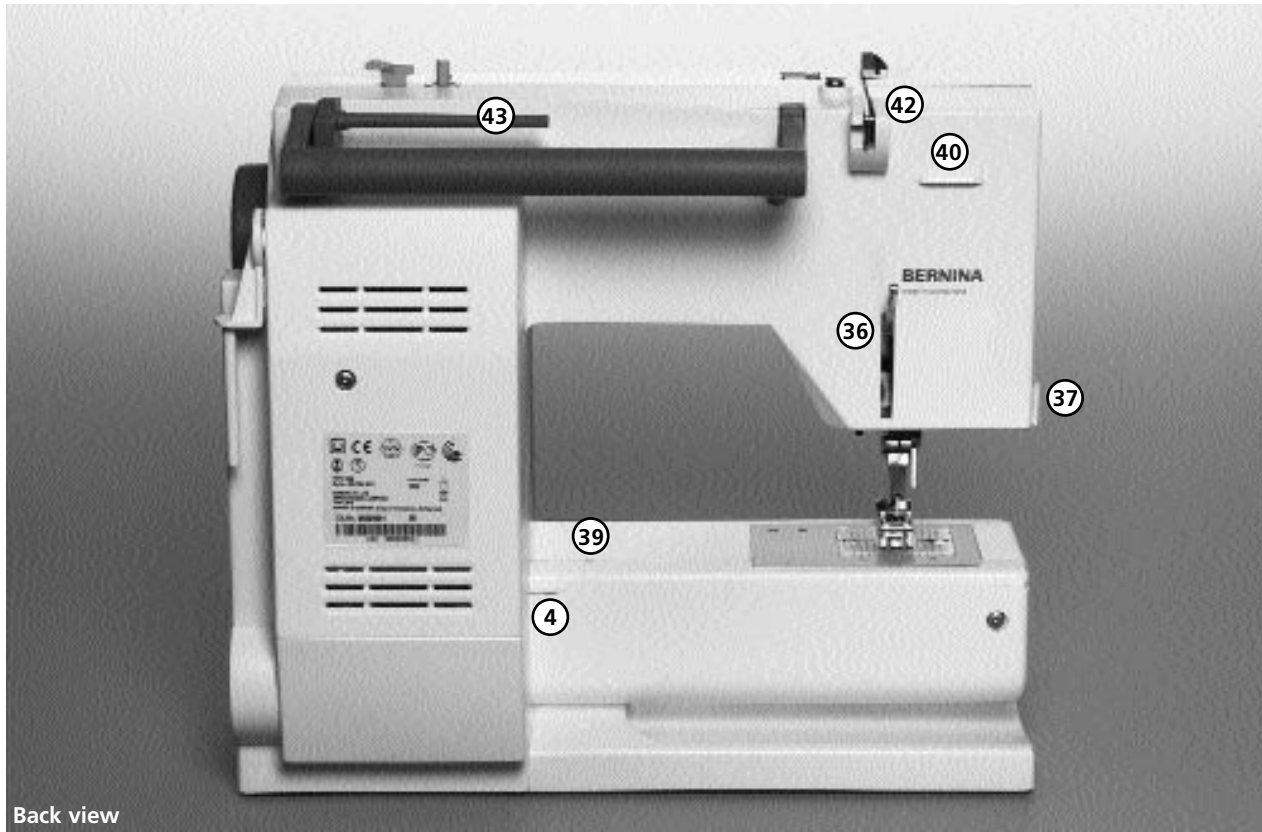

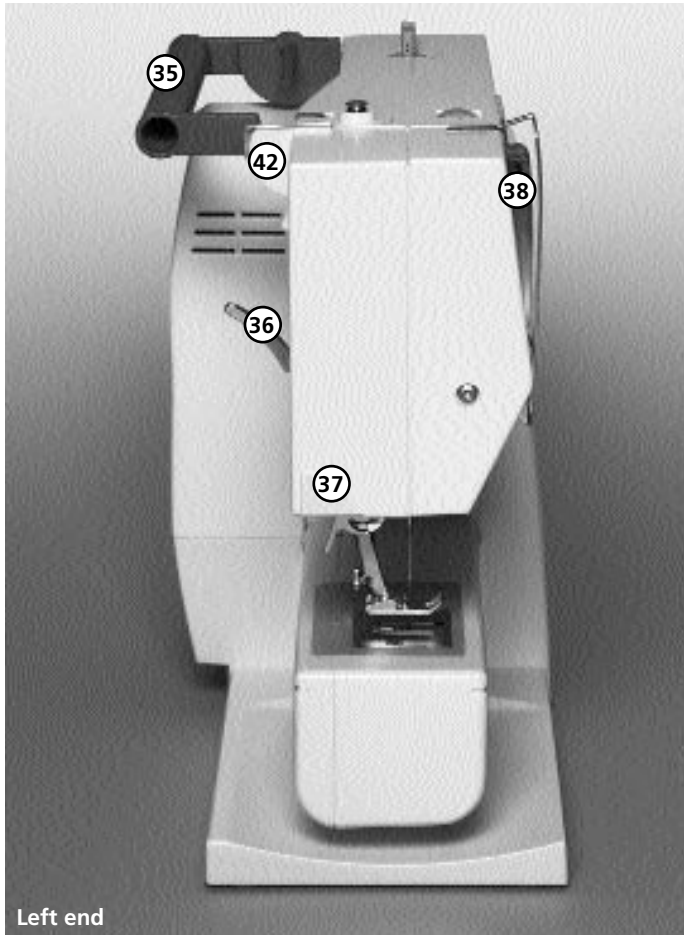

- 35 Carrying handle
- 36 Presser foot lifter (manual)
- 37 Thread cutter
- 38 Thread take up
- 39 Darning ring connection
- 40 Accessory box connection
- 41 Thread tension disc
- 42 Rear thread guide
- 43 Horizontal spool pin
- 44 Accessory box catch

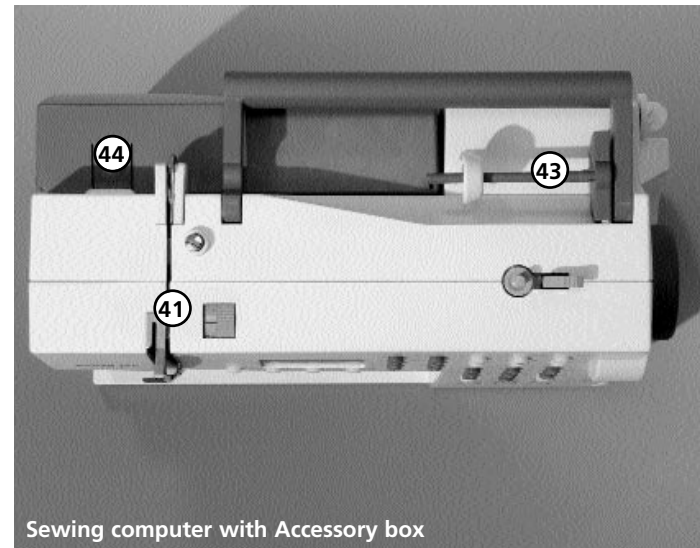



## Accessories

- foot control
- instruction manual
- power cable
- warranty card
- fabric case for standard accessories



### Standard accessories\*:

- 4 bobbins (+ 1 in the capsule in the sewing computer)
- Selection of 130/705H needles
- Seam ripper
- Screwdriver
- Angle key Torx
- Screwdriver Torx
- Lint brush
- Seam guide
- Compensating plate
- 3 spool discs
- Foam pad
- Reverse pattern foot No. 1
- Overlock foot No. 2
- Buttonhole foot No. 3
- Zipper foot No. 4
- Blind stitch foot No. 5

\* can vary from country to country; see presser foot selection p. 24

### Fabric cover\*\*

- protects from dust and dirt
- compartment for accessories

## Start-stop-unit\*\*

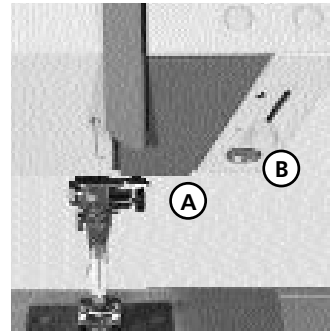

With the Start-stop-unit (SSU) the start-stop-function can be controlled by hand.

- press start-stop-button **A** = stitching starts
- with the speed regulator **B** the sewing speed can be regulated by hand
- to interrupt or stop sewing = press start-stop-button **A** again

### Note:

**If the foot control is connected with the sewing machine, the Start-stop-unit is out functions.**

\*\* available as a special accessory

## Accessory box\*\*

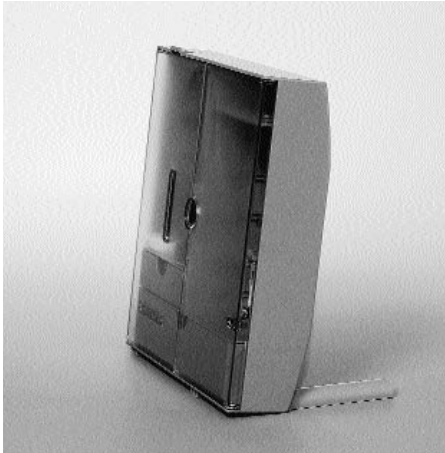

### Free standing accessory box

- pull both feet out until they click into place
- stand box in chosen position

### Storing accessories

Standard accessories are supplied in a plastic bag. The box is equipped with one small and one large drawer (B and C) as well as compartments for bobbin holders D and presser feet E. (Additional compartments and drawers are available as optional extras.)

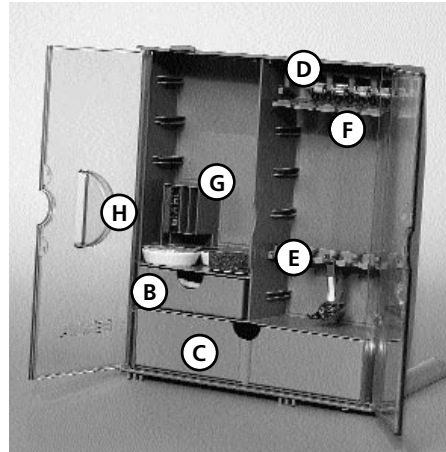

- push the bobbins into the compartments provided
- to remove a bobbin, press the compartment holder F lightly
- insert the presser foot shaft into the slot E
- the snap-on soles can be stored in the big drawer C
- the needle selection box can be stored in compartment G

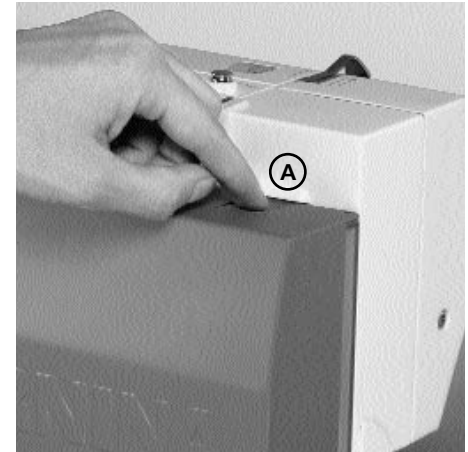

### Attaching the accessory box to the sewing computer

- close the doors
  - push feet back into position
  - attach the box to the sewing computer (catch A must engage); inserting the presser foot lifter into the opening H
- Note:** first lower the presser foot lifter!

### Removing the accessory box

- press catch A on the top of the box
- remove box to the rear

\*\* available as a special accessory

## Power cable

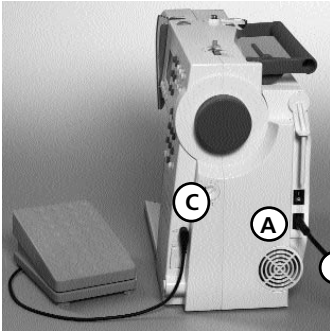

### The power cable

- plug **A** into sewing computer
- plug **B** into wall socket

### Foot control cable

- plug **C** into sewing computer

### Important! (USA/Canada only)

This sewing computer has a polarized plug (one blade wider than the other). To reduce the risk of electric shock, this plug is intended to fit in a polarized outlet only one way. If the plug does not fit fully in the outlet, reverse the plug. If it still does not fit, contact a qualified electrician to install the proper outlet. Do not modify the plug in any way.

## Power switch

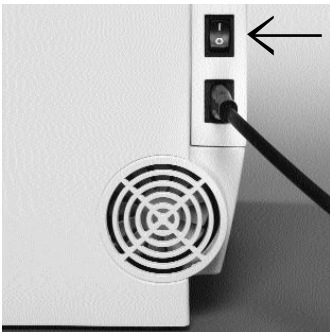

The switch is on the handwheel side of the computer

- 1** the computer is switched on
- 0** the computer is switched off

The sewing light is switched on and off with the power switch.



**Refer to the safety instruction!**

## Foot control

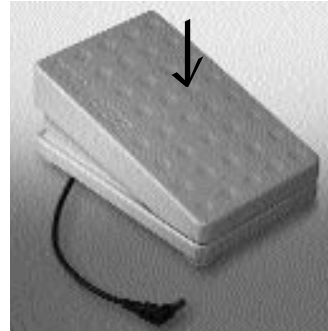

### The foot control regulates the sewing speed

Sewing speed is adjusted by applying more or less pressure to the foot control.

### Important! (USA/Canada only)

Use only foot controller type SR-1 with sewing computers activa 135/145.

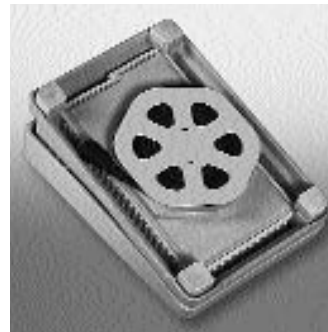

### Self storing cord

- wind the cord on the reel
- insert the plug into the groove provided

### When sewing

- unwind the cable

## Sewing table

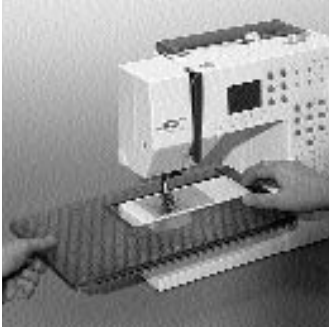

Increases the sewing surface.

### To attach

- raise the needle and presser foot
- place the table over the free arm and press firmly so that it engages on the fixing cam

### To remove

- raise the needle and presser foot
- pull the table out of the fixing cam
- pull in horizontal position to the left

### Scale

- «0» corresponds to the centre needle position

### Seam guide

- insert into the groove (under-side of table) from the right or left
  - it can be freely adjusted over the whole width of the table
- Note:** Remove the presser foot when attaching the seam guide!

## Free-Hand-System (FHS) presser foot lifter\* (knee-operated)

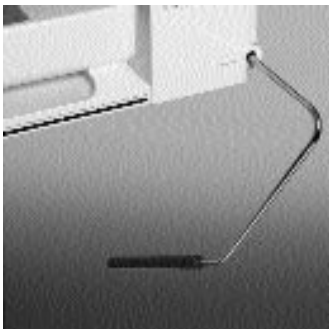

### Attaching the presser foot lifter

Insert into the opening in the base plate: you should be able to operate the lifter with your knee in your normal sitting position.

### Note:

**Your dealer can adjust it if necessary.**

### The presser foot lifter raises and lowers the presser foot

- push to the right
- the presser foot is raised
- the feed-dog is lowered simultaneously
- the feed-dog is raised as soon as the first stitch is sewn

\* Available as a special accessory

## Winding the bobbin

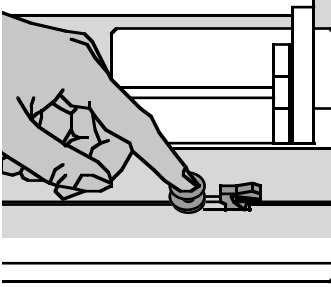

### Winding the bobbin

- turn power switch on
- place empty bobbin on spindle

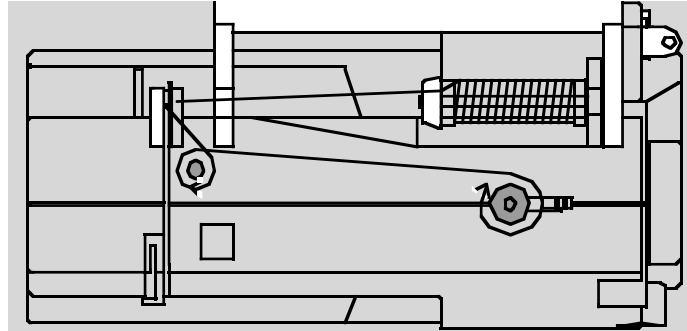

- following the direction of the arrow take thread through the rear guide and round the pre-tension stud
- wind it several times round the empty bobbin
- press the engaging lever against the bobbin
- press the foot control
- the motor will stop automatically when the bobbin is full
- remove the bobbin

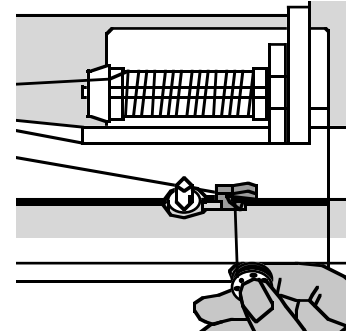

### Thread cutter

- cut the thread on the thread cutter

### Note:

When winding the bobbin on the vertical spool holder (p. 15), it may be necessary to adjust the speed.

## Bobbin case

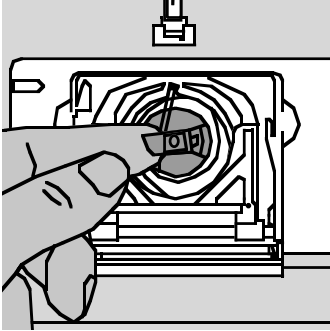

### To remove the bobbin case

- raise the needle
- turn power switch to «0»
- open the bobbin cover
- grasp the latch of the bobbin case
- remove case

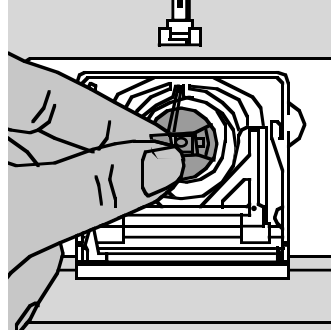

### To insert the bobbin case

- hold the bobbin case latch
- the finger on the case should point upwards
- insert so that it clicks into place

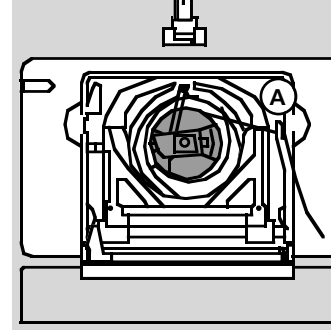

### Bobbin thread cutter

- insert the bobbin case
- take the thread over cutter **A**
- thread is cut
- close the bobbin cover

### Note:

**The bobbin thread does not have to be brought up as the loose end is just the right length to start sewing.**



**Refer to the safety instruction!**

## Inserting the bobbin

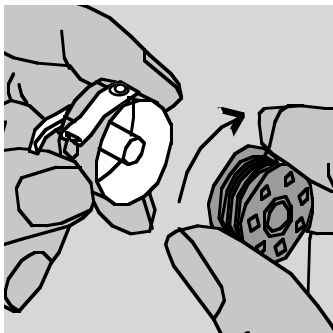

### Insert the bobbin

Insert the bobbin so that the thread runs clockwise.

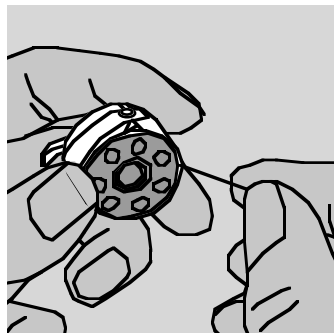

Pull the thread counter clockwise into the slot.

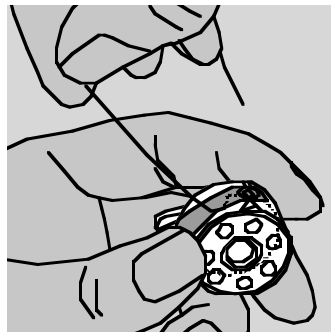

Pull the thread to the left under the spring until ...

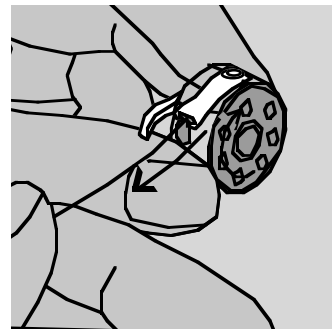

... it lies in the T-shaped slit at the end of the spring.  
The bobbin must turn clockwise when thread is pulled.

## Changing the needle

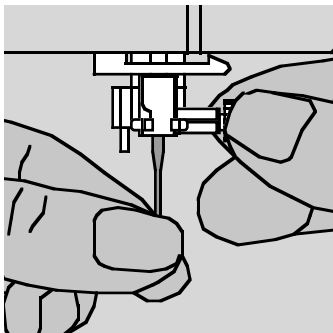

### Removing the needle

- raise the needle
- turn power switch to «0»
- lower the presser foot
- loosen the needle clamp screw
- pull the needle down to remove

### Inserting the needle

- flat side of needle to the back
- insert the needle as far as it will go
- tighten the needle clamp screw



**Refer to the safety instruction!**

## Changing the presser foot

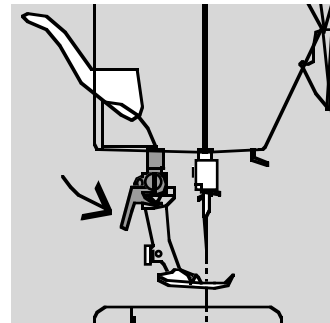
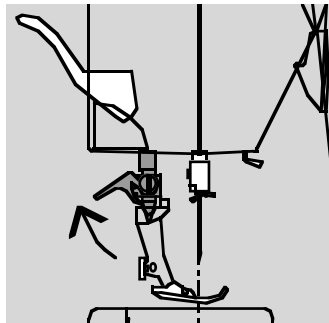
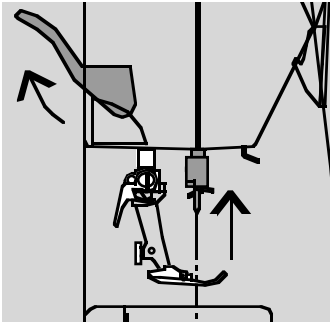

### Presser foot with shank

- raise the clamping lever and presser foot
- turn power switch to «0»

- raise the clamping lever
- remove the presser foot

### Attaching the presser foot

- guide the foot upwards over the cone
- press the clamping lever down



Refer to the safety instruction!

## Supplementary spool pin

### Collapsible vertical spool pin

- found on the back of the sewing computer behind the handwheel
- essential aid for sewing with more than one thread, i.e. double needle work
- raise the pin until it clicks into its vertical position
- when using large reels, add the foam pad **A** for stability

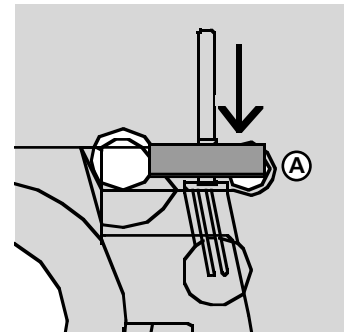
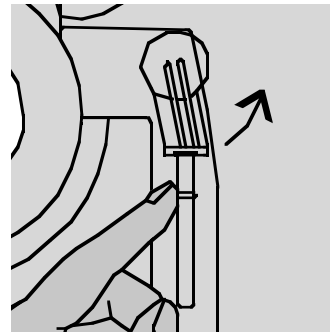



## Threading the upper thread

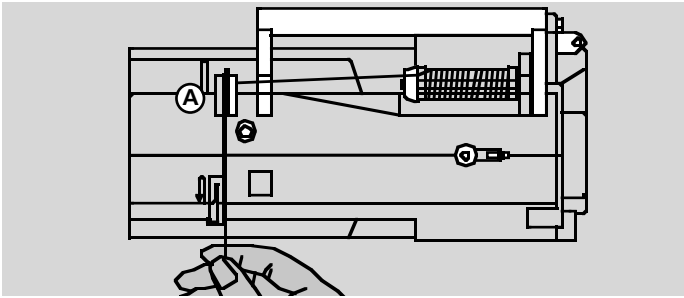

- raise the needle and presser foot
- turn the power switch to «0»
- place spool on pin and attach the appropriate spool disc – diameter of spool = disc size
- take thread through rear guide **A**
- then into slit of upper thread tension
- pull thread down to the right of the take-up cover to **B**
- then up to the left of the cover to **C**
- and down through guides **D** and **E**

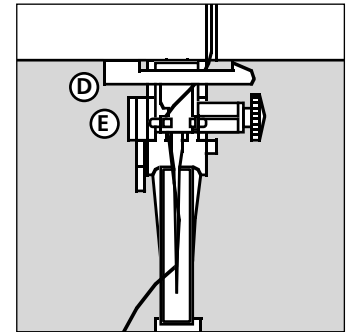
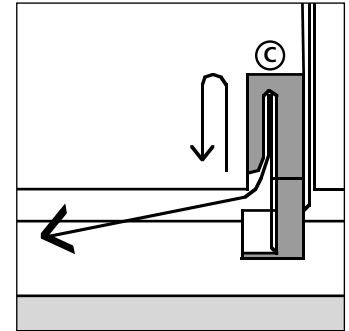
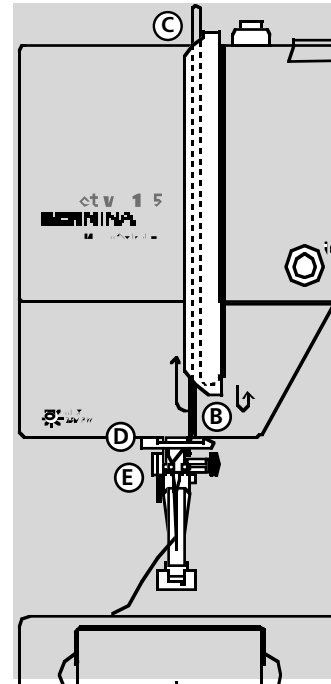

Refer to the safety instruction!

## Bringing up the lower thread

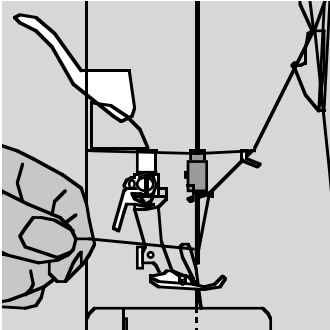

- hold the upper thread
- sew one stitch
- pull the upper thread until the bobbin thread appears in the stitch plate hole
- pull bobbin thread out of the hole and insert both threads through the slit in the presser foot towards the back
- pull threads over the cutter

### Note:

**The bobbin thread must be brought up through the stitch plate for certain types of work. The length of thread is sufficient for most normal work if the lower thread cutter has been used.**

## Thread cutter

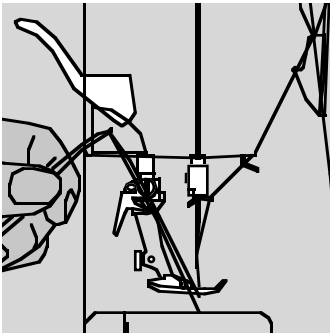

- pull both threads from front to back over the cutter
- the threads release as soon as the first stitch is sewn

## Stitch plate

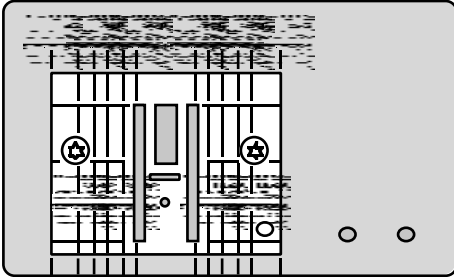

### Stitch plate markings

- the stitch plate is marked with seam guide lines in mm and inches
- the millimetre markings are at the front
- the inch markings are at the back
- the measurements show the distance (with needle position centre) from needle to line
- lines are provided to the right and left of the needle
- they are very useful guide lines for precise seaming
- the horizontal lines are useful for sewing corners, etc.

## Feed-dog

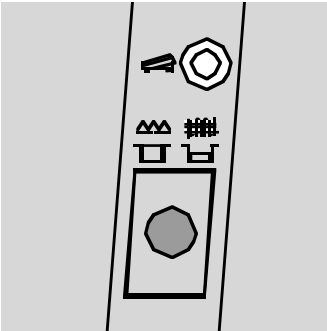

### Button below the handwheel



Button flush with housing =  
sewing position

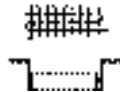

Button depressed = feed-dog is lowered  
• for free-hand sewing (darning, embroidery, etc.)

# Thread tension



## The basic setting

- is indicated when the red line on the tension adjustment wheel is in line with the marking **A**
- the tension does not need adjusting for normal sewing work
- for special sewing work, the tension can be adjusted to suit the fabric

## To reduce the tension

turn to between 3 and 1

## To increase the tension

turn to between 5 and 10

## The tension is factory set for the best results.

**Metrosene 100/2 (Arova Mettler, Switzerland) is used to set both the upper and lower thread tension.**

If other sewing or embroidery threads are used, the tension may need adjusting to suit the fabric and chosen stitch.

## For example:

	Tension	Needle
<b>Metallic thread</b>	approx. 3	90
<b>Monofilament</b>	approx. 2–4	80

## General instructions

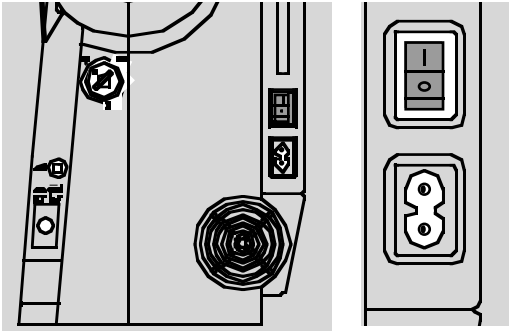

### Main switch to 1

- the sewing sewing computer is ready to sew

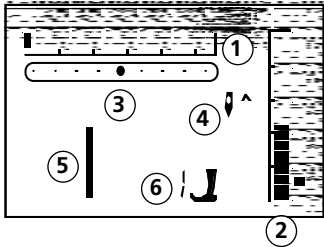

### The screen shows

- 1 stitch width basic setting blinks constantly
- 2 stitch length basic setting blinks constantly
- 3 needle position (9 positions)
- 4 needle stop up/down (generally up)
- 5 stitch number 1 (straight stitch)
- 6 presser foot number 1 indicator (recommended foot for selected stitch)

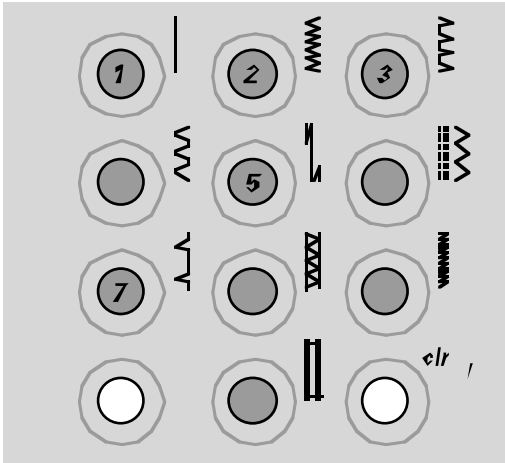

### Stitch\* selection

- stitches 1–10:  
touch the number of your choice; stitch number and basic width and length settings appear
- Note: touch «0» to select stitch number 10 (standard buttonhole)
- to select stitches 11–30 (activa 135) or 11–50 (activa 145):  
touch #-button and the appropriate number

\* see p. 29 for the complete stitch selection; for activa 135 PE see appendix A1

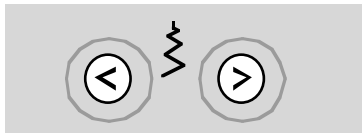

### Stitch width

- left button = narrow the stitch width
- right button = widen the stitch width
- the basic settings of the chosen stitch blink constantly

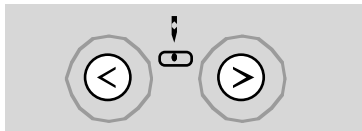

### Needle position

- left button = needle to the left
- right button = needle to the right

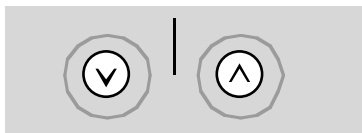

### Stitch length

- left button = shorten the stitch length
- right button = increase the stitch length

## Functions

Functions are ...

**activated** when the symbol appears on the screen.

**deactivated** when the symbols no longer appear on the screen.



### Reverse sewing

#### quick reverse:

- press button
- Sewing computer sews reverse until button is released (max. stitch length 3 mm)

Applications:

- programming buttonholes
- programming darning program
- switch to straight stitch securing program (stitch No. 5)
- manual securing (seam begin and end)

#### continous reverse:

- press button quickly twice
- the sewing computer sews the chosen stitch in reverse
- press button once to cancel

### 1/2 speed

- press the button and the sewing speed will be halved
- press the button again to revert to full speed

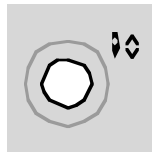
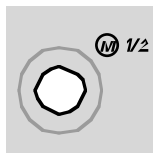

### Needle stop

- basic setting needle stop up
- press button
- arrow points down = sewing computer stops with needle down
- press button again
- arrow points up = sewing computer stops with needle up

#### Note:

Press key a bit longer = the needle will go automatically up or down.

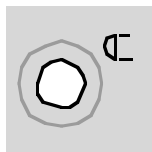

### Stitch end

- press button
- sewing computer stops at the end of a single stitch or stitch combination (in Memory)

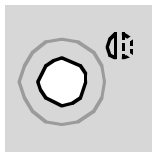

### Mirror image\*

- press button
- mirror image of selected stitch will be sewn

\*activa 145 only

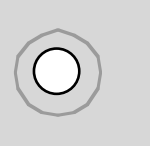
**#-button**

Stitch selection button (see p. 21)

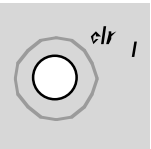
**clr/del (clear/delete)**

- press button = reverts to basic settings
- other selected functions are cleared

**Exceptions:**

- needle stop down
- 1/2 speed
- altered basic settings for buttonholes = press «clr/del»-button twice

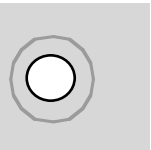
**Letters, numbers and punctuation marks (only activa 145)**

- press the alphabet button
- letters appear on the screen
- press the right button to scroll letters and numbers forwards (A B C ...)
- press the left button to scroll letters and numbers backwards (9 8 7 ...)

**Alphabet contents**

ABCEFGHIJKLMNOPQRSTUVWXYZ  
 \_-.'! ? % ( ) [ ] Ä Ö Ü Å Æ Æ Ø Ñ Ë Ê Ë Æ Æ  
 0123456789

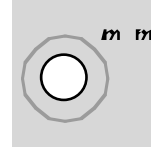
**mem (Memory)**

- press the centre button to open memory (capacity of 30)
- use the left and «mem+»-buttons to scroll and programme stitches, letters and numbers

**Altered Stitch Memory**

- any stitch length or width alterations will be saved automatically

For example:

- sew altered stitch, e.g. zig-zag
- select another stitch, e.g. straight stitch
- return to zig-zag, your alterations are still active

**Return to basic settings**

- basic settings can be restored manually for individual stitches
- all altered settings are lost when the «clr/del»-button is pressed or when the sewing computer is turned off

**Application:**

- for all stitches and fabrics
- particularly useful for switching between different applications



## Memory

Any combination of 30 stitches, letters or numbers can be saved in Memory, which is long term. They remain saved until deleted by the user. Power failures or disconnection from the electricity

supply do not affect the Memory. Alterations to the stitch length, width or needle position can be made at any time. Individual stitches, letters or numbers can be deleted or overwritten.



### Memory buttons

- press left button (<) to scroll contents backwards
- press centre button (mem) to open and close Memory
- press right button (mem+) to scroll contents forwards



### Example: saved stitch

- saved stitch (28) is shown

To program stitches see p. 25

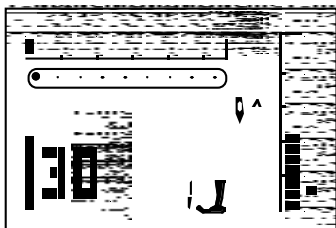

### Open Memory

- press «mem»-button to open Memory
- if the Memory is empty, the cursor and number 30 (= empty memories) blink
- if the Memory is not empty, the saved stitches, letters or numbers appear on the screen; scroll forwards until the cursor and number of empty memories blink

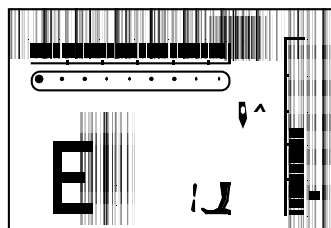

### Example: saved letter

- saved letter (E) is shown

To program letters and numbers see p. 26

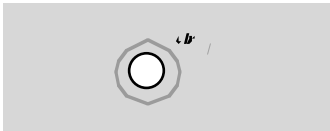

### Delete complete Memory

- press «clr/del» and «mem+»-button at the same time
- release both buttons
- leave Memory by pressing the mem button
- Memory is now completely deleted

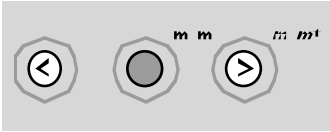

### Scroll backwards

- press left button = the programmed stitch numbers scroll backwards

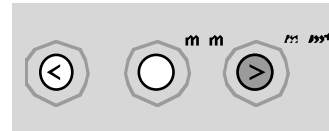

### Scroll forwards

- press «mem+»-button = the programmed stitch numbers scroll forwards

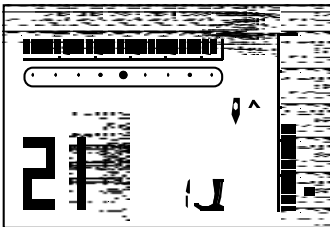

### Programming practical and decorative stitches

- open Memory (p. 24)
- select stitch (p. 21)
- stitch number appears on the screen (here 21)
- press «mem+» to program (save)
- the number of remaining empty memories (here 29) and the cursor blink
- select next stitch, press «mem+» and continue in this manner

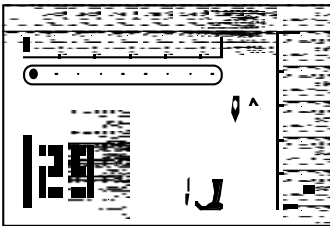

### Begin sewing

- press the foot control = the sewing computer starts automatically at the beginning of a stitch sequence
- select Pattern End (P) as well = the sewing computer stops automatically at the end of a stitch sequence

### Note:

The following special programs cannot be saved in Memory:  
 No. 5, Securing program  
 Nos. 10–12, Buttonholes  
 No.13, Button sewing-on program  
 No. 14, Darning program  
 No. 15, Basting stitch

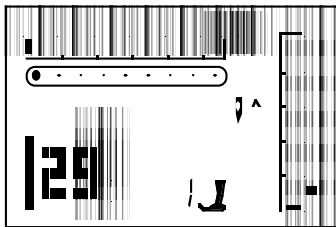

### Programming letters, numbers and punctuation marks (activa 145 only)

- open Memory (p. 24)
- press Alphabet button
- select letter or number (p. 23)
- press «mem+» to program (save)
- the number of remaining empty memories (here 29) and the cursor blink
- select next letter/number, press «mem+» and continue in this manner
- programme single words or sentences/numbers
- select ( ) to program spacing

#### Note:

**If the stitch length and/or width of letters or numbers have been altered, the alterations will affect all of them. If you only want to alter single letters or numbers, this must be done individually.**

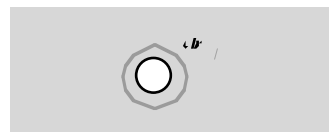
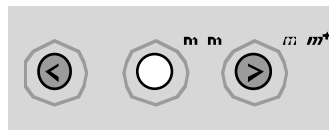

### Corrections in Memory

#### Changing individual stitches, letters and numbers

- scroll with the right or left button to find the stitch you want to change or correct
- then correct or change:
  - stitch
  - letter
  - number
  - stitch length or width
  - needle position
  - etc.
- press «mem+» to save the change(s)

#### Delete single stitch, letter or number

- scroll to find the stitch
- press «clr/del» to delete
- stitch/letter/number is deleted

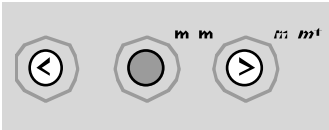

### Leave Memory

- press «mem»-button = contents are saved
- Memory is closed

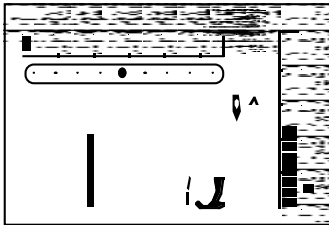

«mem»-symbol disappears from the screen

**The contents of the memory remain saved even when the sewing computer is disconnected from the electricity supply. They can be recalled at any time.**

**The contents of the memory will be lost if the sewing computer is switched off without pressing the mem button before closing the memory.**

## Balance

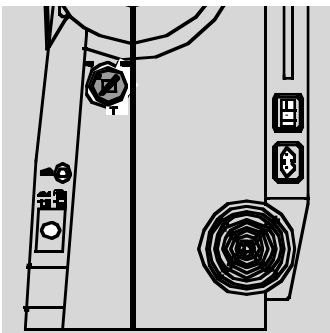

Your sewing computer has been tested and factory set using a double layer of cretonne fabric and Metrosene 100/2 threads (Arova Mettler, Switzerland).

Different fabrics, threads and stabilisers can naturally affect the stitch balance so that they are sewn too close together or not close enough.

Applications:  
Practical stitches, e.g. Honeycomb stitch on jersey, decorative stitches, fantasy stitches, letters, buttonholes, etc.

This can be remedied with Balance to suit the fabric and produce perfect results.

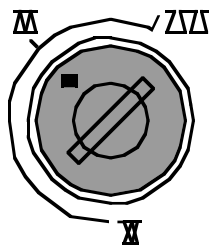

Normal position

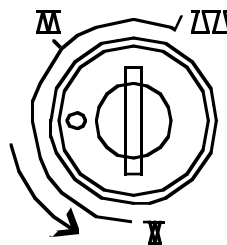

Denser stitch formation  
(shorter stitch length)

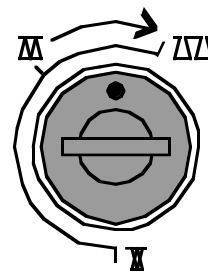

Finer stitch formation  
(longer stitch length)



**Note:**  
If the balance has been adjusted, return it to the normal setting once sewing is completed.

# Stitches\*

## Practical and decorative

- 1 Straight stitch
- 2 Zig-zag
- 3 Vari-overlock
- 4 Running stitch
- 5 Securing stitch
- 6 Triple straight and zig-zag
- 7 Blind stitch
- 8 Double overlock
- 9 Super stretch stitch
- 10 Standard buttonhole
- 11 Keyhole buttonhole
- 12 Straight stitch buttonhole
- 13 Button sewing-on program
- 14 Darning program
- 15 Basting stitch
- 16 Sewn-out zig-zag
- 17 Universal stitch
- 18 Gathering stitch
- 19 Honeycomb stitch

### activa 135

- 20–22 Quilting stitches  
23–30 Decorative stitches

### activa 145

- 20–28 Quilting stitches  
29–50 Decorative stitches

\*activa 135 PE see appendix A1

### activa 135

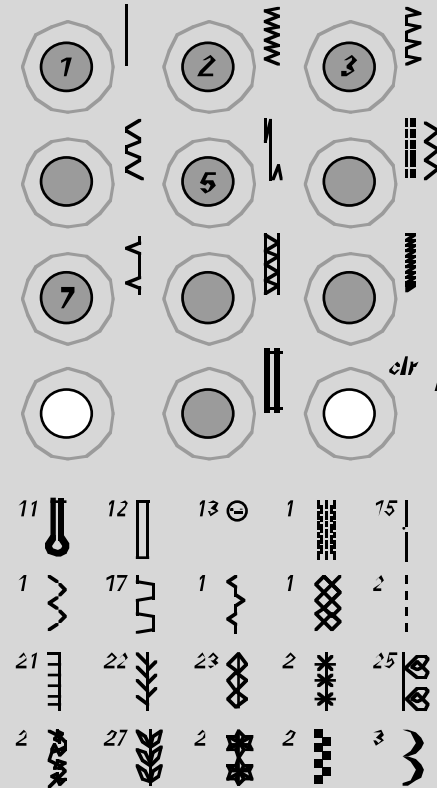

### activa 145

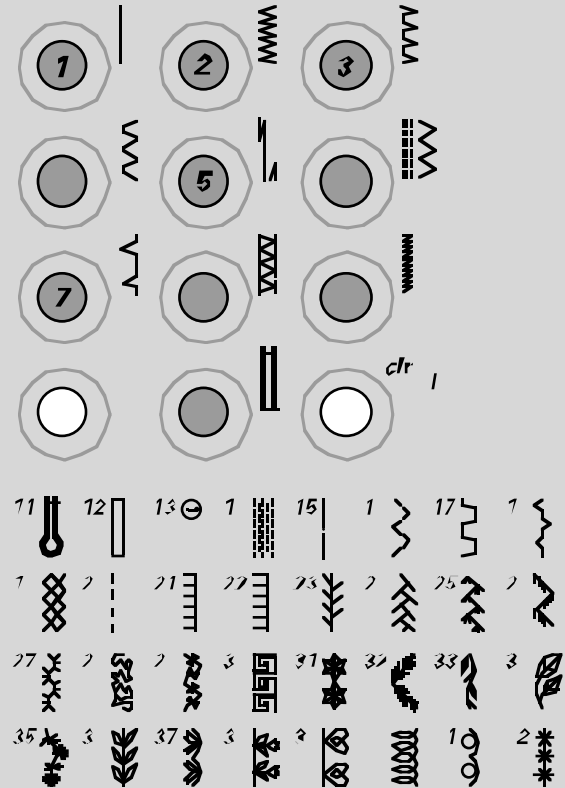

## Stitch selection\*

**1 Straight stitch**

All non-stretch fabrics. All straight stitch work

**2 Zig-zag**

Most fabric types; all simple zig-zag such as oversewing fine fabrics. Sewing on elastic and lace

**3 Vari-overlock**

Primarily for fine jerseys, stretch overlock seams and hems

**4 Running stitch**

Most types of fabric. Mending, patching, reinforcing seams

**5 Securing stitch**

All types of fabric. Secures the beginning and end of seams sewn with straight stitch

**6 Triple straight and triple zig-zag**

Reinforced seams in tough, heavy fabrics

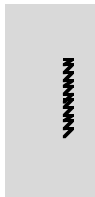
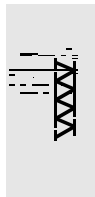
**7 Blind stitch**

Most types of fabric; blind hems, shell edging on soft jerseys and fine fabrics, decorative seams

**8 Double overlock**

All types of knit; Overlock = sew and neaten in one operation

**9 Super stretch**

Open seam for all super-stretch fabrics

\*activa 135 PE see appendix A

**14 Darning program**

Automatic darning for fine and medium weight fabrics

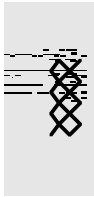
**19 Honeycomb stitch**

Most types of interlock and smooth fabrics; visible seams and hems

**20 Quilt/hand stitching**

Hand stitched effect: only the one stitch (lower thread) is visible; the other stitch (upper thread = monofilament) is invisible; increase upper thread tension to suit the fabric (6–9)

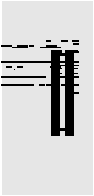
**10 Standard buttonhole**

Fine to medium weight woven fabrics; blouses, shirts, trousers, bedlinens, etc.

**11 Keyhole buttonhole**

Heavy weight, non stretch fabrics. Jackets, coats, trousers, leisure wear, etc.

**12 Straight stitch buttonhole**

Pre-stitch program for bound buttonholes (Foot No. 3A) or pocket openings (Foot No. 3, special accessory)



## Presser foot selection

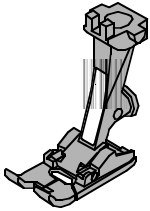

1

### Reverse pattern foot

Practical and decorative stitches

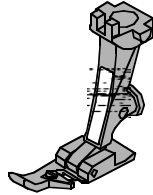

2

### Overlock foot

Overlock seam, hems, oversewing edges, narrow satin stitch

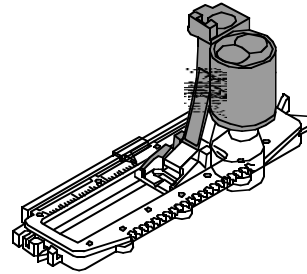

3A

### Buttonhole foot with slide

Buttonhole on smooth fabrics, darning

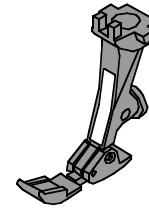

4

### Zipper foot

Sewing in zips

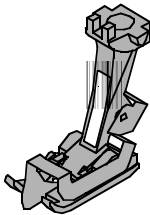

5

### Blind stitch foot

Blind hems, edge stitching

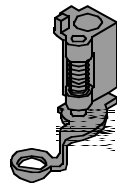

9

### Darning foot

Freehand quilting for light to medium weight quilts; darning

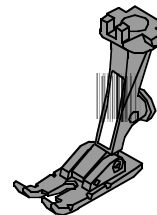

37

### Patchwork foot

Patchwork with seam allowance 1/4" or 1/8" (≈ 6 or 3 mm)  
(available as a special accessory for activa 135)

## Securing program



Stitch: **Securing program No. 5\***  
 Needle: **size and type suitable for the fabric selected (see p. 55)**  
 Thread: **cotton/polyester**  
 Feed-dog: **raised (sewing position)**  
 Presser foot: **Reverse pattern foot No. 1**

### Securing program

- for all fabrics
- secures seam begin and end
- sews exactly over the previous stitches

### Seam begin

- sewing computer secures automatically (5 stitches forwards, 5 reverse)
- continues sewing straight stitch forwards

### Seam end

- press the reverse button = sewing computer secures automatically (5 stitches reverse, 5 forwards)
- stops automatically when securing is complete

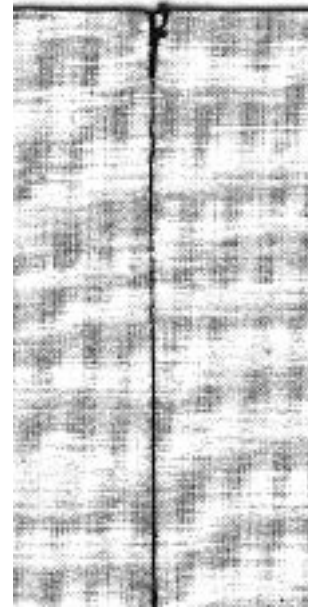

\* 135 PE see appendix A2

## Basting stitch

Stitch: **Basting stitch No. 15 (activa 135 PE No. 14)**  
Needle: **size and type suitable for the fabric selected (see p. 55)**  
Thread: **cotton/polyester**  
Feed-dog: **lowered (darning position)**  
Presser foot: **No. 9**

### Basting stitch

- for all work which requires a very long stitch
- for basting seams, hems, quilts, etc.
- easy to remove

### Preparation:

- pin work horizontally to basting direction to prevent the layers slipping

### Basting

- lower the feed-dog
- position work under the presser foot and sew one stitch; hold threads when starting to sew
- pull work from behind to the required length of the stitch
- sew one stitch and repeat the procedure

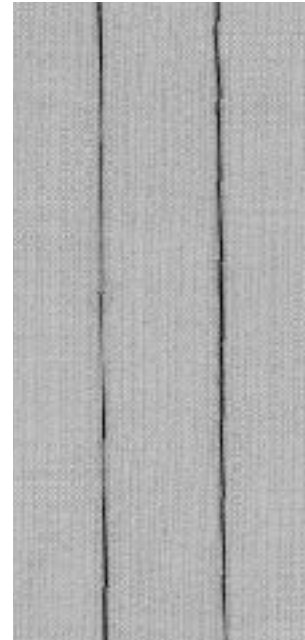

### TIP

#### Securing/fixing the thread

- sew a few basting stitches at the beginning and end of a seam

### Basting

- use a fine darning thread for basting as it is easier to remove

## Blind hem



Stitch: **Blind stitch No. 7**  
 Needle: **size and type suitable for the fabric selected (see p. 55)**  
 Thread: **cotton or polyester**  
 Feed-dog: **up (sewing position)**  
 Presser foot: **Blind stitch foot No. 5**

### Blind hem

for «invisible» hems in medium to heavy cotton, wool and blended fabrics

### Preparation

- neaten raw edges
- prepare seam as for sewing by hand
- place work under the presser foot (see drawing)

### Sewing

- the needle should just pierce the edge of the fold (same as hand sewing)
- adjust the stitch width to suit the fabric
- after sewing about 10 cm (4"), check both sides of fabric and adjust width again if necessary

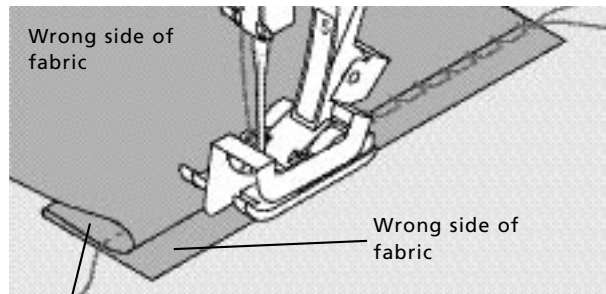

Right side of fabric



### TIP

#### Fine stitch width adjustment

Guide the folded edge evenly along the metal guide on the foot = even depth

## Darning program



Stitch: **Darning Program No. 14 (activa 135 PE No. 13)**  
 Needle: **size and type suitable for the fabric selected (see p. 55)**  
 Thread: **darning thread**  
 Feed-dog: **up (sewing position)**  
 Presser foot: **Reverse pattern foot No. 1**  
**Buttonhole foot No. 3A**

### Quick darning of holes or worn areas

Replacement of damaged fibres/threads

### Darning with Reverse pattern foot No. 1 (auto stitch counter)

- insert needle in top left of damaged area
- sew the first length and stop the sewing computer
- press the securing button: length is programmed
- complete the darn; the sewing computer stops automatically

Large areas:

- the darning area can be extended by moving the work under the foot
- clear the programme by pressing the «clr/del»-button

### Darning with Buttonhole foot with slide No. 3A

- use for small tears and damaged areas, not more than 3 cm (1<sup>1</sup>/<sub>4</sub>" ) long
- use same method as with foot No. 1

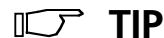
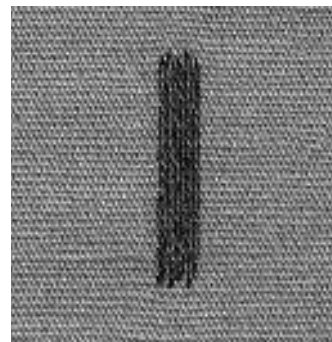

## TIP

### Reinforcement

use fine fabric or interlining as a backing

### Preparation

stretch fabric into darning ring\* prevents puckering

\*The darning ring is available as a special accessory

# Zippers

- Stitch: **Straight stitch No. 1**  
 Needle: **size and type suitable for the fabric selected (see p. 55)**  
 Thread: **cotton or polyester**  
 Feed-dog: **up (sewing position)**  
 Presser foot: **Zipper foot No. 4**  
 Needle position: **far right or far left**

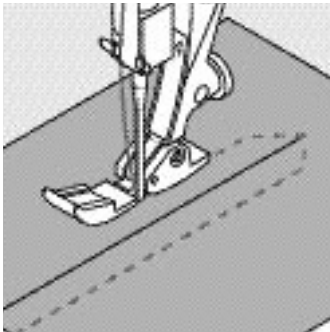

## Preparation:

- baste in zipper
- fabric edges should meet over the center of the zipper

## Sewing

- sew in the zipper, each side from bottom to top
- once with needle position far right and once with needle position far left
- the edge of the foot runs along the teeth of the zip
- the needle inserts close to the teeth

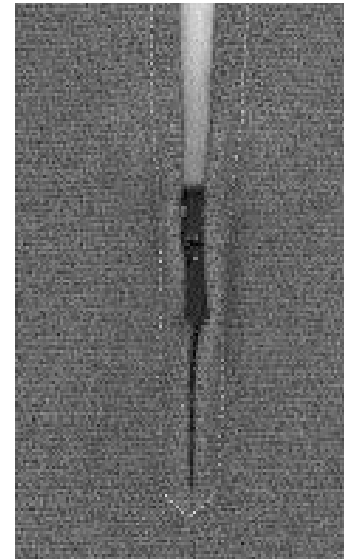

## TIP

### To sew around zipper pull

- close zipper and sew up to about 5 cm (2") away from the pull
- insert needle, raise the presser foot, open the zipper, lower the foot and continue to sew

### Seam begin

hold thread firmly when starting to sew = pull fabric slightly to the back (fewer stitches)

### Zipper or fabric is thick or densely woven

use a 90–100 needle for even stitch formation

## Everything you need to know about buttonholes

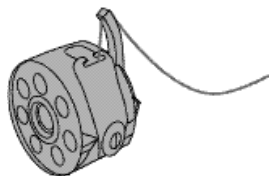

**Buttonholes are not only practical closures, they can also be used to decorative effect**

Select the buttonhole of your choice (No. 10 or 11); the following appears on the screen:

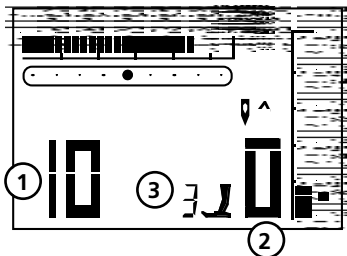

- 1 Buttonhole number
- 2 Buttonhole symbol
- 3 Presser foot number

### Thread tension

- thread the bobbin thread through the finger of the bobbin case = the bobbin tension is a little tighter
- this gives the beads on the right side of the fabric a slightly rounded appearance
- the buttonhole looks more attractive
- gimp reinforces buttonholes and enhances their appearance (pages 46, 47)

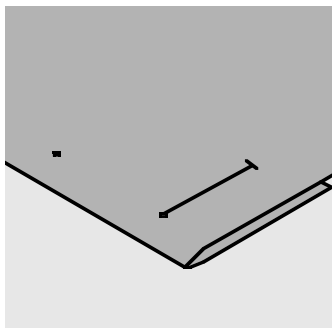

### Mark the length of automatic buttonholes

- mark the length of just one buttonhole
- after sewing the first buttonhole, the length for all subsequent buttonholes is automatically programmed
- mark only the beginning of all subsequent buttonholes

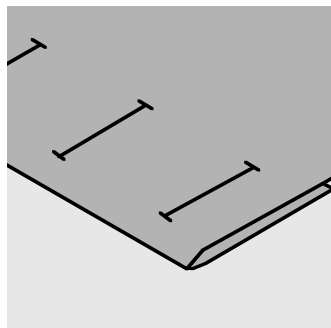

### Mark the length of manual buttonholes

- mark the buttonhole length in the appropriate position
- stitch using buttonhole foot No. 3 (optional accessory)

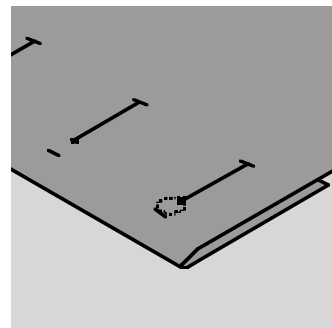

### Mark the length of keyhole buttonholes

- mark the bead length only
- the correct length eye will be added when the buttonhole is sewn

**Test sewing**

- always test sew on the fabric and stabilizer you intend to use
- select the buttonhole type you intend to use
- sew the buttonhole in the same direction on the fabric (with or against the grain)
- cut the buttonhole open
- push the button through and adjust the buttonhole length if necessary

**Corrections****To adjust the bead width:**

- alter the stitch width
- altered stitch widths can be deleted by pressing the «clr/del»-button

**Altering the stitch length:**

- any alterations to the stitch length affect both beads (denser or less dense)
- altered stitch length can be deleted by pressing the «clr/del»-button

**Note:**

**When all buttonholes have been sewn, return balance to the normal setting!**

**Balance for automatic/manual buttonholes**

- any balance alterations to the 6-step manual and auto length buttonholes affects both beads identically because they are sewn in the same direction

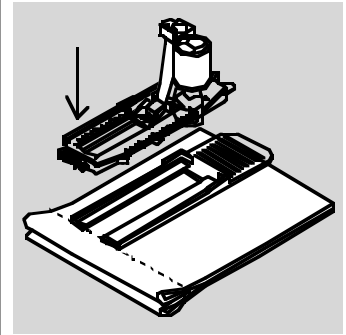
**TIP**

If a buttonhole is to be sewn at right angles to a seam, we recommend the use of the buttonhole leveler. Insert the plate from behind between the fabric and the foot up to and over the thicker area.



## Automatic standard buttonhole with auto length

Both beads are sewn in the same direction.

### Note:

The automatic buttonhole foot No. 3A must lie perfectly flat on the fabric. If the foot lies on a seam, the length cannot be measured accurately.

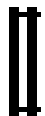

Stitch:  
Needle:  
Thread:  
Feed-dog:  
Presser foot:

**Standard buttonhole No. 10**

**size and type suitable for fabric selected (see p. 55)**

**cotton or polyester**

**up (sewing position)**

**Automatic buttonhole foot No. 3A**

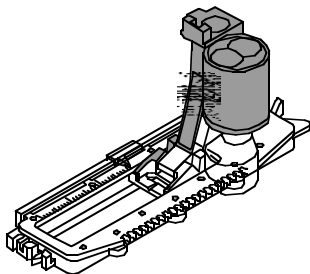

### Automatic standard buttonhole

- insert the lower thread in the finger of the bobbin case (p. 38)
- when using Buttonhole foot No. 3A, the length of the buttonhole is automatically registered by the lens on the foot = exact duplication and automatic sequence change when the maximum length has been sewn
- each step of the sewing sequence blinks on the screen

### Note:

**When any automatic buttonhole is selected, presser foot No. 3 is indicated on the screen.**



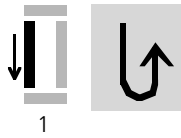

1

### Programme the standard buttonhole

- 1 sew the first bead forwards, stop the sewing computer
  - press the reverse button
  - «auto» and presser foot No. 3A are indicated on the screen = the buttonhole length is programmed

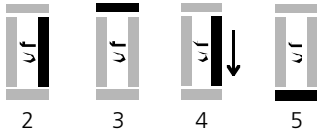

2

3

4

5

- 2 the sewing computer sews reverse straight stitch automatically
- 3 the first bar tack
- 4 the second bead forwards
- 5 the second bar tack and securing stitches

- sewing computer stops and returns automatically to buttonhole begin

### Auto buttonhole

- all subsequent buttonholes will be sewn to exactly the same length (no need to press the reverse button)
- press the «clr/del»-button to delete the programme
- the programmed buttonhole can be saved in the long term memory (see p. 48)

### Corrections see p. 39

### Balance

- any changes to the balance affect both beads of auto length buttonholes, because both beads are sewn in the same direction

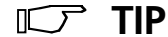

### TIP

#### Exact duplicates

the auto function ensures that each buttonhole will be exactly the same length as the previous one

#### Marking

mark only the beginning of the buttonholes – a real time saver!

#### Sewing speed

- sew at moderate speed for best results
- sew all buttonholes at the same speed for a consistent bead density

#### Compensating plates for buttonholes (special accessory)

If a buttonhole is to be sewn horizontally to the edge of the garment, it is worth using the compensating plates.

This accessory provides an even surface for the buttonhole foot with slide which results in a perfect buttonhole (see tips p. 39).

### Note:

**When all buttonholes have been sewn, return balance to the normal setting!**

## Automatic keyhole buttonhole with auto length



Stitch: **Keyhole buttonhole No. 11**  
 Needle: **size and type suitable for the fabric selected (see p. 55)**  
 Thread: **cotton or polyester**  
 Feed-dog: **up (sewing position)**  
 Presser foot: **Automatic buttonhole foot No. 3A**

Both beads are sewn in the same direction.

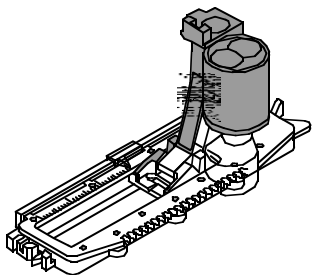
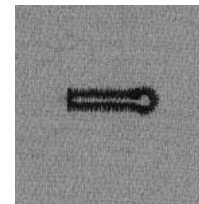

### Automatic keyhole buttonhole

- insert the lower thread in the finger of the bobbin case (p. 38)
- when using Buttonhole foot No. 3A, the length of the buttonhole is automatically registered by the lens on the foot = exact duplication and automatic sequence change when the maximum length has been sewn

### Marking the keyhole buttonhole

- mark the bead length only. The correct eye length will be added when the buttonhole is sewn.
- each step of the sewing sequence blinks on the screen

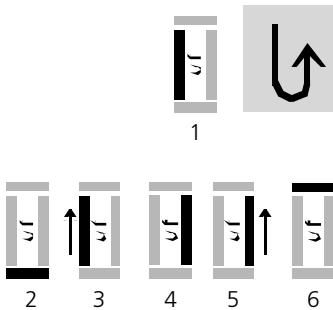

### Programming the buttonhole

- 1** sew the straight stitch forward, stop the sewing computer,
  - press the reverse button
  - auto and presser foot No. 3A are displayed on the screen = buttonhole length is programmed
- 2** the sewing computer automatically sews the eye
- 3** the first bead in reverse
- 4** sews second straight stitch
- 5** sews second bead in reverse
- 6** sews bartack and securing stitches
  - the sewing computer stops and returns automatically to buttonhole begin

### Auto buttonhole

- all subsequent buttonholes will be sewn automatically to the same length (without pressing the reverse button)
- Press the «clr/del»-button to delete the programme
- the programmed buttonhole can be saved in the long term memory (see p. 48)

### Corrections see p. 39

### Balance

- any changes to the balance affect both beads of auto length buttonholes, because both beads are sewn in the same direction
- any distortions to keyhole buttonholes can be corrected with balance

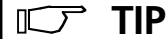

### TIP

#### Exact duplicates

the auto function ensures that each buttonhole will be exactly the same length as the previous one

#### Marking

mark only the beginning of the buttonholes – a real time saver!

#### Double sewn keyhole buttonholes

- keyhole buttonholes can be sewn twice on thick fabrics
- after sewing the first buttonhole, do not move the work
- simply tap the foot control once to begin sewing again

### Note:

**When all buttonholes have been sewn, return balance to the normal setting!**

## Manual buttonhole (all types)

Manual buttonholes are particularly suitable for single buttonholes or for repairing existing buttonholes.

Individual steps can be eliminated or repeated. The number of steps corresponds to the buttonhole type. Manual buttonholes cannot be saved.

Stitch:	<b>any buttonhole</b>
Needle:	<b>size and type suitable for the fabric selected (see p. 55)</b>
Thread:	<b>cotton or polyester</b>
Feed-dog:	<b>up (sewing position)</b>
Presser foot:	<b>Buttonhole foot No. 3 (optional accessory)</b>

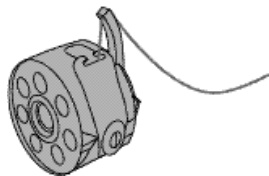

### Preparation

- select the desired buttonhole
- screen shows:
  - buttonhole number (10 or 11)
  - presser foot No. 3
  - the buttonhole symbol (the first step blinks on the screen)
- insert the lower thread in the finger of the bobbin case

### Always test sew buttonholes

- test on the fabric and stabilizer you intend to use
- sew buttonholes in the same grain direction (with or against)

**Note: Corrections see p. 39**

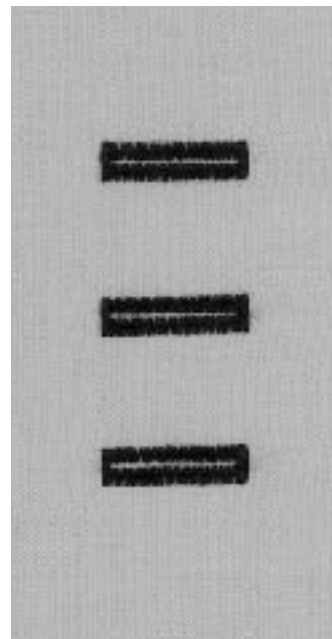

**Sewing a manual standard buttonhole**

Both beads are sewn in the same direction.

The individual steps blink on the screen.

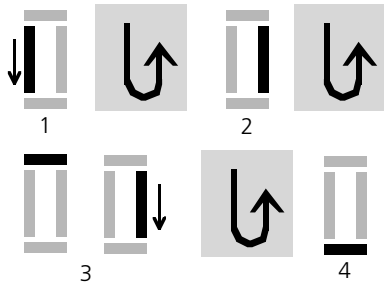

- 1 sew the first bead forward, stop the sewing computer
  - press the reverse button
- 2 sew reverse straight stitch, stop the sewing computer at the first stitch (buttonhole begin)
  - press the reverse button
- 3 sew the bartack and the second bead, stop the sewing computer
  - press the reverse button
- 4 sew the bartack and the securing stitches

**Manual keyhole buttonhole**

Sew both forward and reverse beads at the same speed.

The individual steps blink on the screen.

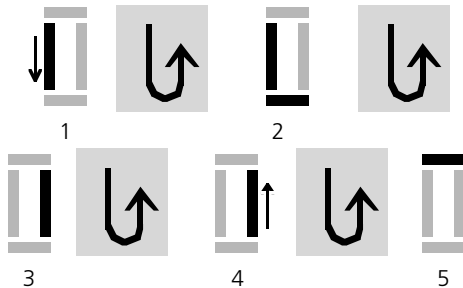

- 1 sew straight stitch forwards, stop the sewing computer, press the reverse button
- 2 sew the eye and the first bead in reverse, stop the sewing computer at the first stitch (buttonhole begin), press the reverse button
- 3 sew straight stitch forwards and stop at the keyhole, press the quick reverse button
- 4 sew the second bead in reverse, stop the sewing computer at the first stitch (buttonhole begin), press the reverse button
- 5 sew bartack and securing stitches

## Buttonhole with gimp

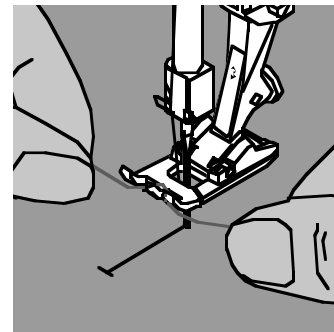
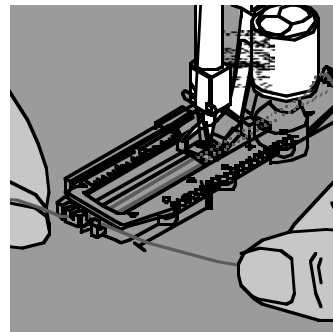
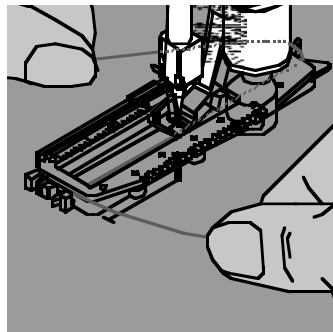
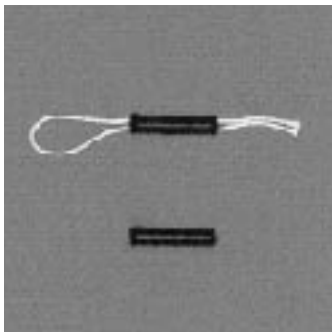

### Gimp

- gimp cord reinforces buttonholes and enhances their appearance
- the loop of the cord should be at the end of the buttonhole most subject to wear  
cord loop = where button is sewn on
- position the work accordingly
- gimp cord is particularly recommended for standard and stretch buttonholes

### Ideal cords

- Perle yarn No. 8
- strong hand sewing thread
- fine crochet yarn

### Hooking the cord in the buttonhole foot with slide No. 3A

- insert the needle at the beginning of the buttonhole
- raise the presser foot
- guide the cord under the foot to the right
- hook the cord over the pin at the back of the foot

- bring the cords to the front of the foot

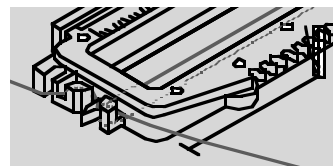

- pull them into the slit
- sew the buttonhole

### Hooking the cord onto presser foot No. 3

- insert the needle at the beginning of the buttonhole
- raise the presser foot
- hook the cord over the centre pin on the front of the foot

### Sewing

- sew the buttonhole in the usual manner
- do not hold the cord tightly
- the buttonhole will form over the cord, covering it

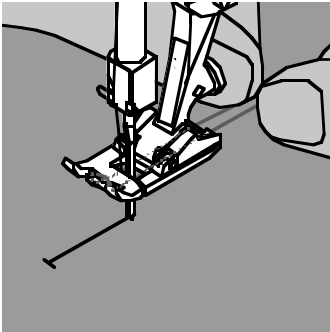

- place both ends of the cord in the grooves on the sole of the foot and pull them to the back
- lower the presser foot

### Sewing

- sew the buttonhole in the usual manner
- do not hold the cord tightly
- the buttonhole will form over the cord, covering it

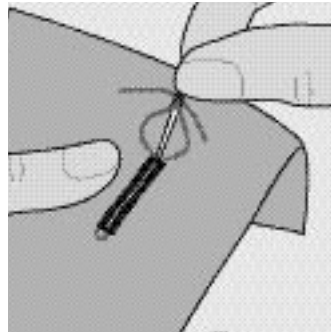

### Securing the cord

- pull the cord through the buttonhole
- pull cords through to back of fabric
- knot or secure with stitches

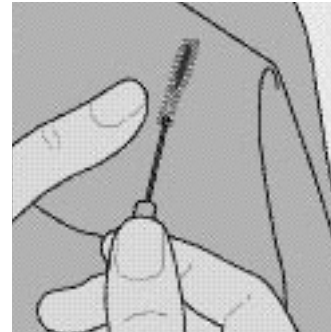

### Cutting buttonholes open with the seam ripper

- use the back of the seam ripper to nick the stitches
- cut from both ends towards the middle

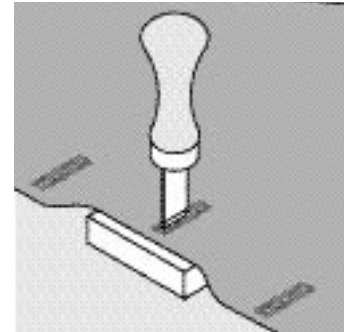

### Buttonhole cutter and block (special accessory)

- place the fabric on the wood
- place the cutter in the centre of the buttonhole
- press down on the cutter with your hand or a hammer



## Programmed buttonholes

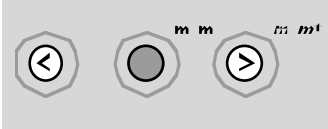

### Saving programmed buttonholes in long term memory

- after programming press the «mem+»-button
- the buttonhole is now saved in long term memory

### Opening saved buttonholes

Programmed saved buttonholes can be opened for re-use even after the sewing computer has been disconnected.

- select the buttonhole
- press the «mem»-button
- sew the programmed buttonhole
- only one of any style buttonhole can be saved, if a new length is saved with «mem+», it overwrites the previously saved buttonhole

## Button sewing-on program



- Stitch: **Button sewing-on program No. 13 (activa 135 PE No. 12)**  
 depends on distance between the holes
- Needle: **size and type suitable for the fabric selected (see p. 55)**  
 cotton or polyester
- Thread: **down (darning position)**
- Feed-dog: **Foot No. 9**
- Presser foot: **Button sew-on foot No. 18 (optional accessory)**

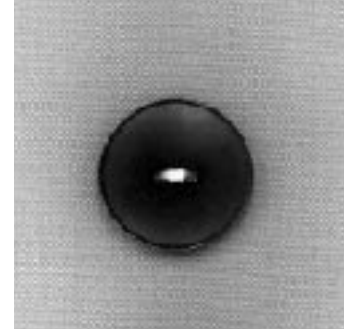
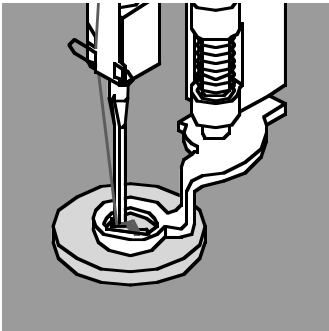

### Sewing on buttons

- sews buttons with 2 or 4 holes
- buttons being sewn on for decorative purposes only  
 can be stitched without forming a thread shank
- the length of the shank (= thread between button and fabric)  
 can be made shorter or longer as required with foot No. 18

### Sewing on buttons with foot No. 9

- select Button Sew-on program
- sew the securing stitches; hold the threads when starting to sew
- check distances between holes with the handwheel and adjust  
 stitch width if necessary
- sew
- sewing computer stops automatically when program is  
 completed and is ready for the next button

### Beginning and ending threads

- the threads are secured and can be trimmed

### For added security

- after sewing on the button, pull the upper thread ends  
 through to the wrong side and knot

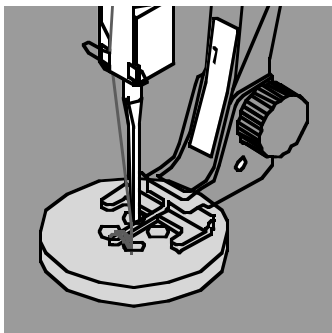
**Sewing on buttons with foot No. 18**

- set the shank length with the screw on the foot
- select Button sewing-on program and continue as with foot No. 9 (p. 49)

**Beginning and ending threads**

- the threads are secured and can be trimmed

**For added security**

- after sewing on the button, pull the upper thread ends through to the wrong side and knot or
- using the upper thread ends to sew a «shank» by hand

**TIP****4-hole button**

- sew the front holes
- carefully move the button forward
- sew the back holes
- cut the diagonal joining thread

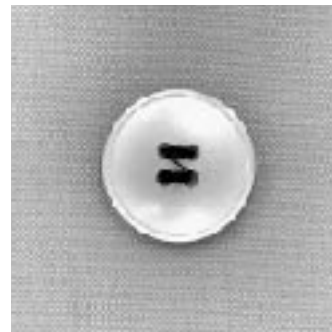

## Vari-overlock seam



- Stitch: **Vari-overlock No. 3**  
 Needle: **size and type suitable for the fabric selected (see p. 55)**  
 Thread: **cotton or polyester**  
 Feed-dog: **up (sewing position)**  
 Presser foot: **Overlock foot No. 2 or  
 Reverse pattern foot No. 1**

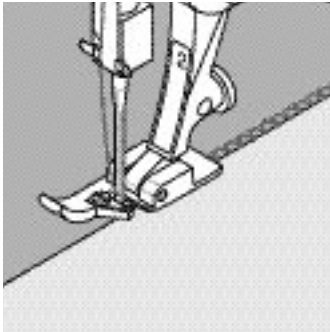

Overlock foot No. 2 is specially designed for overlock stitches. The pin on the foot produces more thread in each stitch so that the elasticity of the seam is maintained.

### Closed seam

Stretchy seam in fine, soft knits such as silk jersey and interlock.

### Sewing

- guide the raw edge along the pin on the overlock foot
- the stitch will form over the pin and over the edge of the fabric



### TIP

#### Knits and jersey

use a new needle to prevent damaging the loops

#### Sewing stretch fabrics

if necessary use a stretch needle (130/705H-S) = needle point slides between the fibers

## Double overlock seam

- Stitch: **Double overlock No. 8**  
 Needle: **size and type suitable for the fabric selected (see p. 55)**  
 Thread: **cotton or polyester**  
 Feed-dog: **up (sewing position)**  
 Presser foot: **Overlock foot No. 2 or  
 Reverse pattern foot No. 1**

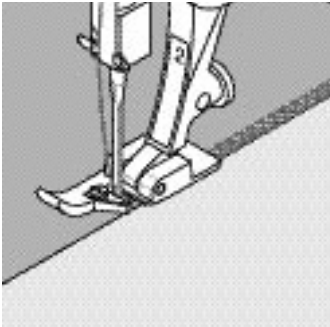

Overlock foot No. 2 is specially designed for overlock stitches. The pin on the foot produces more thread in each stitch so that the elasticity of the seam is maintained.

### Closed seam

overlock seam in loose knits and cross seams in knits and jerseys

### Sewing

- guide the raw edge along the pin on the overlock foot
- the stitch will form over the pin and over the edge of the fabric

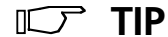
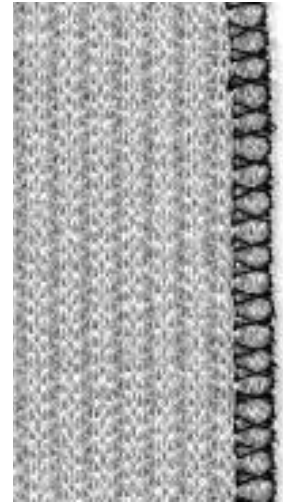

### TIP

#### Knits and jersey

use a new needle to prevent damaging the loops

#### Sewing stretch fabrics

if necessary use a stretch needle (130/705H-S) = needle point slides between the fibers

## Ribbing with overlock seam



- Stitch: **Vari-overlock No. 3**  
 Needle: **size and type suitable for the fabric selected (see p. 55)**  
 Thread: **cotton or polyester**  
 Feed-dog: **up (sewing position)**  
 Presser foot: **Overlock foot No. 2 or Reverse pattern foot No. 1**

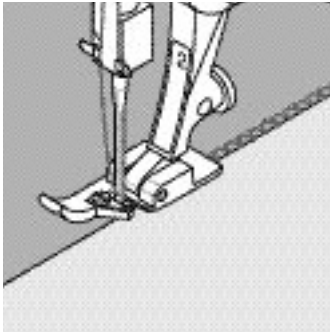

Overlock foot No. 2 is specially designed for overlock stitches. The pin on the foot produces more thread in each stitch so that the elasticity of the seam is maintained.

### Ribbing with overlock seam

for all fine cotton, synthetic and mixed fiber jersey

#### Preparation

- fold ribbing in half
- pin and baste to opening, right side outside

#### Sewing

- sew Vari-overlock over the raw edge
- guide the edge along the pin on the foot

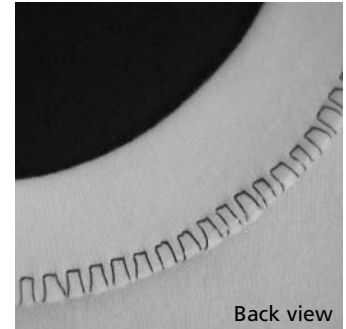

Back view

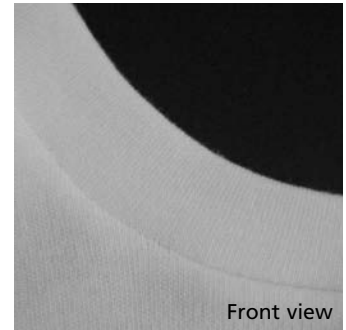

Front view

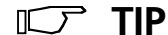

### TIP

#### Needle stop down

needle stays in fabric when you stop to adjust the ribbing

## Self-facing with Honeycomb stitch



Stitch: **Honeycomb No. 19 (activa 135 PE No. 15)**  
 Needle: **universal, ballpoint or stretch as needed**  
 Thread: **cotton or polyester**  
 Feed-dog: **up (sewing position)**  
 Presser foot: **Presser foot: Reverse pattern foot No.1**

### Ribbing with visible seam

for all cotton, wool, synthetic and mixed fiber jersey

### Preparation

press 1 cm (3/8") to wrong side

### Sewing

- sew from the right at a foot's width from the edge
- trim surplus fabric (wrong side)

### Balance/corrections

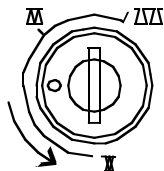

bring stitch together

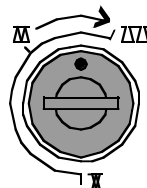

open out stitch



**Note:**  
 After sewing return balance  
 to the normal setting!



### TIP

**Needle stop down**  
 needle stays in fabric when  
 you stop to adjust the ribbing

## Important facts about sewing computer needles

### Sewing computer, needle and thread

Your **BERNINA** uses needle system 130/705H.

### Needle and thread

The most commonly sold needles are nos. 70–120. The finer the needle, the lower the number. The table shows which needle is suitable for which threads.

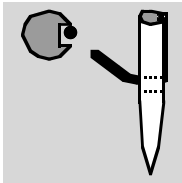

#### Needle appropriate for thread

When sewing, the thread runs in the long groove on the needle.

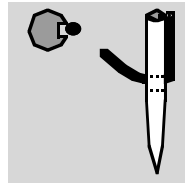

#### Needle inappropriate for thread

If the needle is too fine, the groove will be too narrow for the thread and faulty stitching or thread breakage can occur.

### Needle and fabric

#### Condition of needle

The needle must be in perfect condition. Problems can occur with damaged needles.

Needle	70	80	90	100	110–120
Darning thread	●	●			
Embroidery thread		●			
Mercerised cotton thread		●	●		
Synthetic thread		●	●		
Thick threads, synthetic mercerised thread			●	●	
Buttonhole thread for decorative seams (cordonnet)				●	●

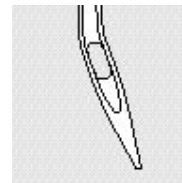

bent needle

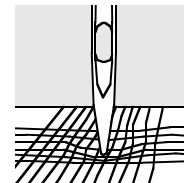

blunt needle

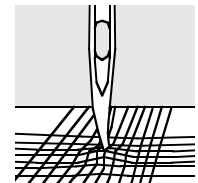







hooked needle

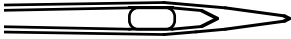

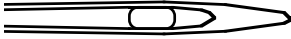
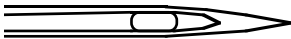
Special materials are easier to sew if the appropriate needle is used.

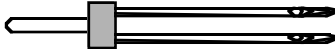
Special needles are available at your **BERNINA** dealer.

Needle table	Description	Needle point	Suitable for	
<b>Standard needle</b>	130/705 H	Normal point, slightly rounded	Universal needle for woven, needle synthetic and natural fibers, e.g. linen, chiffon, batiste, organdie, wool, satin, decorative stitching, embroidery	
<b>Special needles</b>	130/705-SES	Fine ball point	Fine knits, especially for synthetic fibers	
	130/705 H-SUK	Medium ball point	Heavier knits in synthetic or natural fibers	
	130/705 H-S	Medium ball point	Special needle for delicate or difficult stretch fabrics	
	130/705 H-J	Extra fine point	Overalls, heavy linen, denim, canvas. Pierces dense fabrics easily	
	130/705 H-LR + H-LL	Cutting point	Natural and synthetic leather, plastic, coated and waxed fabric	
<b>Double needle</b>	130/705 H ZWI	Widths: 1,6 / 2,0 / 2,5 / 3,0 / 4,0	Visible hems in stretch fabrics, pintucks, decorative sewing	
<b>Triple needle</b>	130/705 H DRI	Widths: 2,5 / 3,0	Decorative sewing	
<b>Hemstitch needle</b>	130/705 H HO	Width: 2,0	Hemstitch in loose weaves	

## Feed-dog and fabric feed

### Feed-dog and stitch length

With each stitch the feed-dog moves forward by one step. The length of this step is determined by the stitch length selected. With an extremely short stitch length, the steps are also short. The fabric moves under the foot quite slowly, even at full sewing speed. Buttonholes, satin stitch and decorative stitches are all sewn with a very short stitch length.

### Important

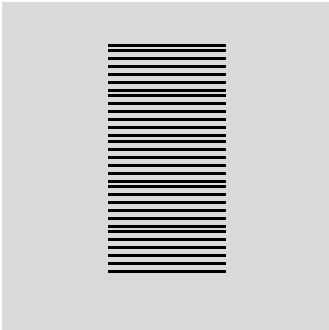

Let the fabric feed evenly!

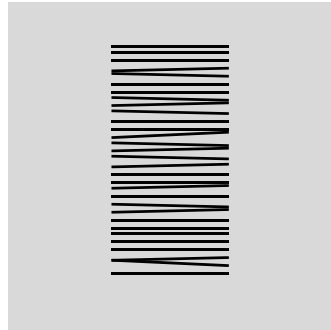

Pulling or pushing will result in gaps.

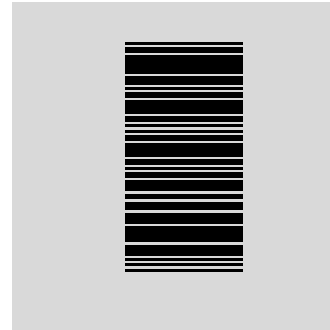

Holding back will result in knots.

### Feed-dog and fabric feed with compensating plates

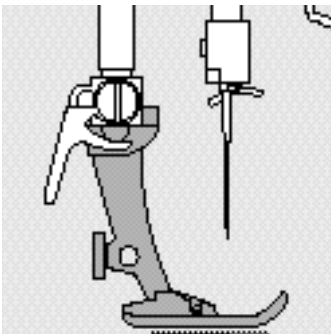

The feed-dog can work normally when the foot is level.

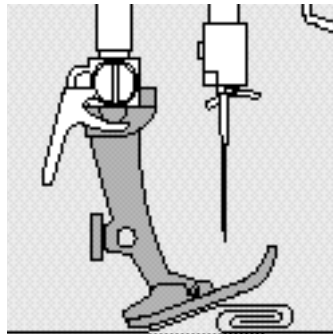

If the foot is at an angle, e.g. when sewing over thick to thin or vice-versa, the feed-dog cannot grip and feed the fabric and the fabric hangs up.

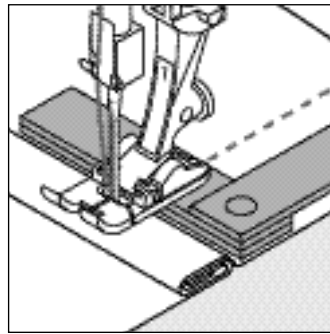

#### Uneven layers

To solve this problem, place one, two or three compensating plates as required behind the needle under the presser foot.

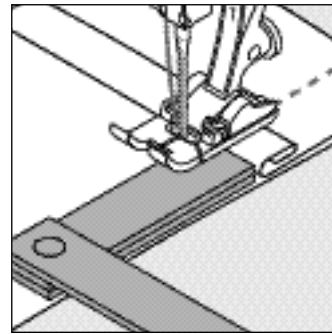

To correct the height in front of the foot, place one or more compensating plates to the right of the foot close to the needle. Sew until the foot is level again and remove the plates.

### Thick fabrics: feed-dog and sewing corners

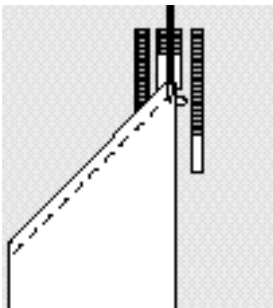

The gap between the two rows of teeth is relatively large due to the width of the stitch plate hole. When sewing corners only a small section of the fabric is actually on the feed-dog so that it cannot grip the fabric well.

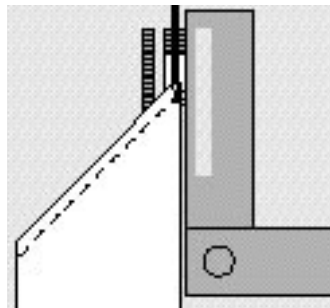

Correct this by placing one or more compensating plates as close as possible to the edge of the fabric.

# Cleaning

If the sewing computer is stored in a cold room, it should be brought to a warm room about one hour before use.

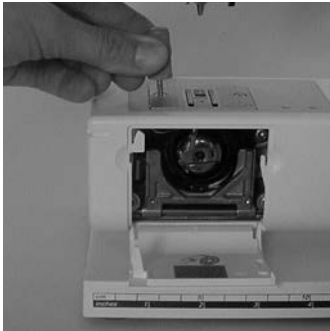

## Cleaning

Clean the sewing computer after every use

- turn power switch to «0»
- remove presser foot and needle
- open the free-arm cover
- unscrew the stitch plate (with screwdriver TORX)
- lift and remove it
- clean the area with the brush
- replace the stitch plate

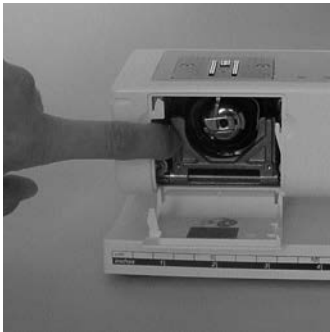

## Cleaning the hook

- turn power switch to «0»
- remove the bobbin case
- push the release lever to the left
- push the locking lever to the left and fold down the hook race cover
- remove the hook
- clean the hook race with a cloth or brush, never use a sharp instrument
- replace the hook, turning the handwheel if necessary so that the hook driver is on the left
- close the hook race cover and secure with the locking lever, the locking pin must engage
- check by turning the handwheel
- insert the bobbin case

## Cleaning the screen and the sewing computer

- wipe with a damp cloth

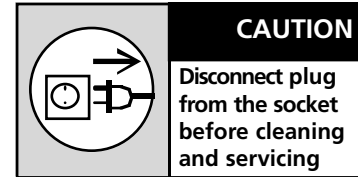

## Lubricating

This sewing computer is equipped with a LM (low mass) hook system which requires no lubrication.

If however you do lubricate any parts, always run the sewing computer immediately afterwards on scrap material to avoid soiling your work.

## Important!

**Never use alcohol, petrol, white spirit or any type of solvent to clean the sewing computer!**



**Refer to the safety instruction!**

## Sewing light

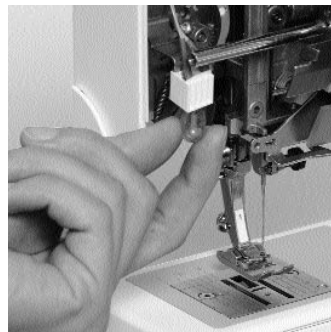
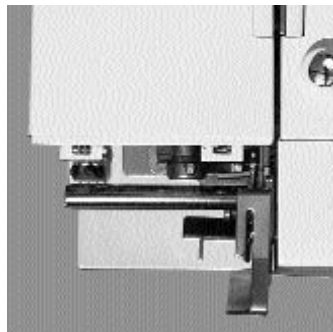
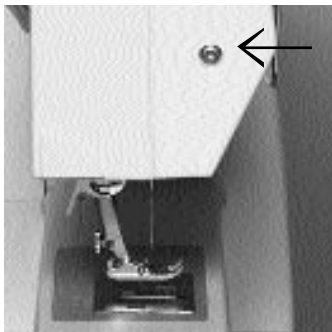

### Replacing the bulb

- turn power switch to «0»
- loosen the screw
- remove the cover by lifting it slightly and detaching from the top
- remove the bulb
- insert the new bulb
- replace cover and tighten screw

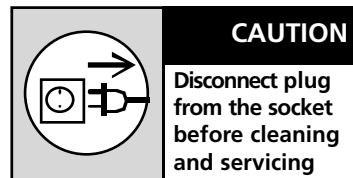

### CAUTION

Disconnect plug from the socket before cleaning and servicing

### Note:

Use bulb type  
12 V 5 W.  
W 2.1 x 9.5 d.

**Light bulbs get hot.  
Allow to cool down before  
removal.**



Refer to the safety instruction!

---

# Trouble shooting

In most cases you will be able to identify and remedy faults by checking the following.

## Check whether:

- the upper and lower threads are threaded correctly
- the needle is inserted correctly
- the needle size is correct – check the needle/thread table p. 55
- the sewing computer is clean – brush out any thread fluff
- the hook race is clean
- any threads are trapped between the tension discs or under the bobbin case spring
- the bobbin runs smoothly in the case or if remnants or lint need removing

---

## Upper thread breaks

- The upper thread tension is too tight.
- The needles are of a poor quality. Ideally needles should be purchased from your **BERNINA** dealer.
- The needle is bent or blunt.
- Poor quality, knotted or dried out thread has been used.
- Use the correct spool disc.
- Stitch plate or hook tip damaged. Take your sewing computer to your **BERNINA** dealer.

---

## Lower thread breaks

- The lower thread tension is too tight.
- The bobbin is jamming in the bobbin case. Remove and replace the bobbin.
- The hole in the stitch plate has been damaged by the needle. This must be repolished by an expert.
- The needle is blunt or bent.

---

## Skipped stitches

- Wrong needles used.  
Use only 130/705H system.
- The needle is blunt, bent or incorrectly inserted.
- Push right to the top when inserting.
- Needle inserted all the way to the top.
- The needle point does not suit the fabric being sewn. If necessary use a ball point for knitted fabrics and cutting point for hard leather.

---

## Needle breaks

- Needle clamp screw loose.
- Fabric taken out in front instead of behind presser foot.
- When sewing over thick area, the fabric was pushed with the needle still in the fabric.
- Poor quality thread, unevenly wound or knotted.
- See pages 55 and 56 for information about needles

---

## Faulty stitching

- Remnants of thread between the tension discs.
- Remnants of thread under the bobbin case spring.
- Lower thread still threaded in the bobbin case finger.
- Sewing computer threaded with foot down.
- Incorrect threading. Check upper and lower threads.
- Use the correct spool disc.

---

## Sewing computer fails to run or runs slowly

- Plug not properly inserted.
- Power switch in off position.
- Sewing computer has been standing in a cold room.
- Bobbin winder still switched on.

---

# Index

## A

---

Accessory box 8, 9

## B

---

Balance 28, 48, 54

Basting stitch 34

Blanket stitch A3

Blind hem 35

Bobbin 12

Bobbin case 13

Bobbin thread cutter 13

Bringing up the lower thread 17

Button sewing-on program 49

Buttonholes 38–48

- Altering buttonholes 48
- Automatic keyhole buttonhole 42
- Automatic standard buttonhole 40
- Buttonhole with gimp 46
- Manual buttonhole 44
- Programmed buttonholes 48

## C

---

Changing the needle 14

Changing the presser foot 15

Cleaning 59, 60

Compensating plates 58

## D

---

Darning program 36

Details of the sewing computer 4–7

Double blanket stitch A3

Double overlock seam 52

## F

---

Fabric cover 8

Fabric feed, Needles, Threads 55–58

Feather stitch A6

Feed-dog 18, 57

Foot control 10

Functions 22

- #-button 23
- 1/2 speed 22
- clr/del (clear/delete) 23
- Letters 23
- mem (Memory) 23
- Mirror image 22
- Needle stop 22
- Reverse sewing 22
- Stitch end 22

## H

---

Handlook quilt stitch A5

Honeycomb stitch 54

## I

---

Inserting the bobbin 14

## K

---

Keyhole buttonhole 42

Knits and jersey 51, 52

## L

---

Letters programming 26

Lower thread 17

## M

---

Maintenance 59, 60

Memory 24

- Balance 28
- Corrections in Memory 26
- Leave Memory 27
- Memory buttons 24
- Open Memory 24

- Programming letters, numbers and punctuation marks 26
- Programming practical and decorative stitches 25
- Scroll backwards/forwards 25
- Stitches 29, 30, 31

---

**N****Needle position 21****Needles, Threads, Fabric feed 55–58**

---

**O****Overlock seam 53**

---

**P****Power cable 10****Presser feet 32**

- Blind stitch foot No. 5
- Buttonhole foot with slide No. 3A
- Darning foot No. 9
- Overlock foot No. 2
- Patchwork foot No. 37
- Reverse pattern foot No. 1
- Zipper foot No. 4

**Presser foot lifter 11**

---

**Q****Quilters securing program A2****Quilt stitch (Handlook quilt stitch) A5**

---

**R****Ribbing with overlock seam 53****Reverse sewing 22**

---

**S****Screen shows 20****Seam guide 11****Securing program 33****Self-facing with Honeycomb stitch 54****Sewing light 60****Sewing table 11****Single blanket stitch A3****Spool pin 15****Standard accessories 8****Standard buttonhole 40****Stiches 29, A1****Stipple stitch A4****Stitch length/width 21****Stitch plate 18****Stitch selection 21****Stretch fabrics 51, 52****Supplementary spool pin 15**

---

**T****Threads, Fabric feed, Needles 55–58****Thread cutter 12, 17****Thread tension 19****Threading the upper thread 16****Trouble shooting 61**

---

**U****Upper thread 16**

---

**V****Vari-overlock seam 51**

---

**W****Winding the bobbin 12**

---

**Z****Zippers 37**



<b>2</b>	<b>Important safety Instructions</b>
<b>4</b>	<b>Details</b>
<b>10</b>	<b>Setting up the sewing computer</b>
<b>20</b>	<b>Operating instructions</b>
<b>29</b>	<b>Stitches</b>
<b>32</b>	<b>Presser feet</b>
	<b>Selected practical stitches:</b>
<b>33</b>	• <b>Securing program</b>
<b>34</b>	• <b>Basting stitch</b>
<b>35</b>	• <b>Blind hem</b>
<b>36</b>	• <b>Darning program</b>
<b>37</b>	• <b>Zippers</b>
<b>38</b>	• <b>Buttonholes</b>
<b>49</b>	• <b>Button sewing-on program</b>
<b>51</b>	• <b>Overlock</b>
<b>54</b>	• <b>Honeycomb</b>
<b>55</b>	<b>Needle, Thread, Fabric Feed</b>
<b>59</b>	<b>Cleaning, Maintenance, Troubleshooting</b>
<b>62</b>	<b>Index</b>
<b>A1–A6</b>	<b>Appendix</b>

**Impressum**

Typesetting, Layout, DTP: Silvia Bartholdi  
Graphics: Müller-Melzer ID, Kreuzlingen

© copyright 2001 by Fritz Gegauf AG, Steckborn

# Stitches

## Practical

- 1 Straight stitch
- 2 Zig-zag
- 3 Vari-overlock
- 4 Running stitch
- 5 Quilters securing program
- 6 Triple straight and zig-zag
- 7 Blind stitch
- 8 Double overlock
- 9 Blanket stitch
- 10 Standard buttonhole
- 11 Keyhole buttonhole
- 12 Button sewing-on program
- 13 Darning program
- 14 Basting stitch
- 15 Honeycomb stitch
- 16 Sewn-out zig-zag
- 17 Universal stitch
- 18 Gathering stitch

## Quilting stitches

- 19 Stipple stitch
- 20 Handlook Quilt stitch
- 21 Double blanket stitch
- 22 Feather stitch

23–30 **Decorative stitches**

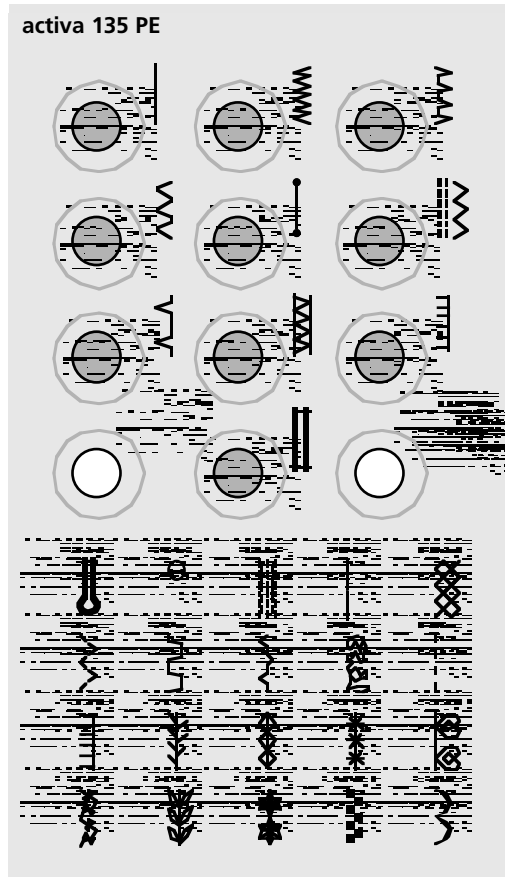

## Quilters securing program

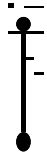

- Stitch: **Quilters securing program No. 5**  
Needle: **80 Quilting, Jeans, Sharp, or Microtex**  
Thread: **cotton/polyester or Monofilament for the upper thread and cotton or polyester for the lower thread raised (sewing position)**  
Feed-dog: **raised (sewing position)**  
Presser foot: **Reverse pattern foot No. 1 or Walking foot No. 50 (optional)**

### Securing program

- for all fabrics
- secures seam begin and end

### Seam begin

- sewing computer secures automatically (6 short stitches forwards)
- continues sewing straight stitch forwards

### Seam end

- press the reverse button = sewing computer secures automatically (6 short stitches forwards)
- stops automatically when securing is complete



### TIP

- when quilting, the quilt securing program can be combined for example with the handlook quilt stitch No. 20
- for work which is likely to be subjected to heavy wear or laundering, use straight stitch No. 1 for securing

# Blanket stitch



- Stitch: **Single blanket stitch No. 9 or Double blanket stitch No. 21**  
 Needle: **80**  
 Thread: **machine thread**  
 Feed-dog: **sewing**  
 Presser foot: **Reverse pattern foot No. 1 or  
 Open Embroidery Foot No. 20 (optional)**  
 Needle position: **center**

## Preparation

- cut desired applique shapes
- fuse or baste as desired to a background fabric

## Sewing

- place the fabric under the needle and position it so the wide portion of the stitch will form on the applique and the straight portion will fall just outside of it on the background fabric
- stitch around entire applique shape

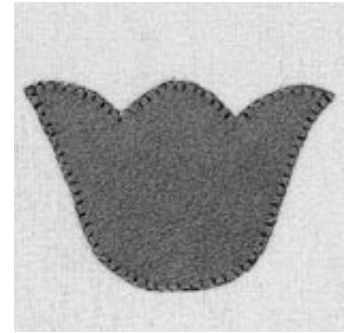

## TIP

- for a hand-stitched look, increase the stitch length and width when appliqueing heavy fabrics such as felt, flannel, and Ultra Suede®

## Stipple stitch



Stitch: **Stipple stitch No. 19**  
Needle: **80**  
Thread: **machine thread**  
Feed-dog: **sewing**  
Presser foot: **Reverse pattern foot No. 1**  
Needle position: **center**

### Preparation

- prepare a «quilt sandwich» by placing a layer of batting between the quilt top and the backing fabric (fabric will be right sides out)
- pin or baste layers together

### Sewing

- place the quilt sandwich under the needle and sew the stipple stitch as desired across the fabric.

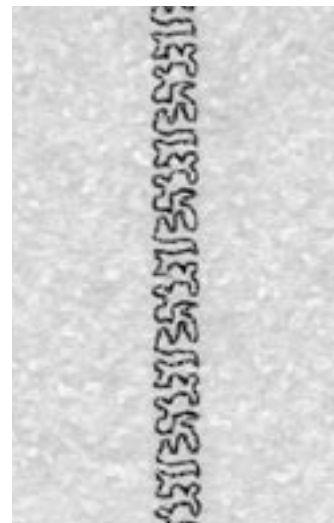

# Handlook quilt stitch



- Stitch: **Hand-look quilt stitch No. 20**  
 Needle: **80 Quilting, Jeans, Sharp, or Microtex**  
 Thread: **0.044 monofilament for the upper thread and 40 or 30 weight cotton for the lower thread**
- Feed-dog: **sewing**  
 Presser foot: **Reverse pattern foot No. 1 or Walking foot No. 50 (optional)**
- Needle position: **as desired**  
 Tension: **tighten to 6–9**  
 Balance: **adjust if necessary**

## Preparation

- prepare a «quilt sandwich» by placing a layer of batting between the quilt top and the backing fabric (fabric will be right sides out)
- pin or baste layers together

## Sewing

- place the quilt sandwich under the needle and sew the hand-look quilt stitch as desired across the fabric
- the bobbin thread should pull to the surface of the fabric and give the appearance of a hand-sewn running stitch

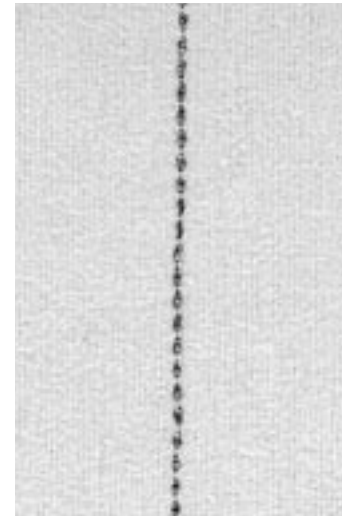

## TIP

- moderate speed for best results

## Feather stitch



Stitch: **Feather stitch No. 22**  
Needle: **80**  
Thread: **machine thread**  
Feed-dog: **sewing**  
Presser foot: **Reverse pattern foot No. 1 or  
Open Embroidery Foot No. 20 (optional)**  
Needle position: **center**

Use this delicate embroidery stitch to embellish fabric or to cover patchwork seams.

### Preparation

- piece patchwork shapes as desired

### Sewing

- place the fabric under the needle and position it so the center portion of the stitch will fall «in-the-ditch» of the seam
- stitch, embellishing seams as desired

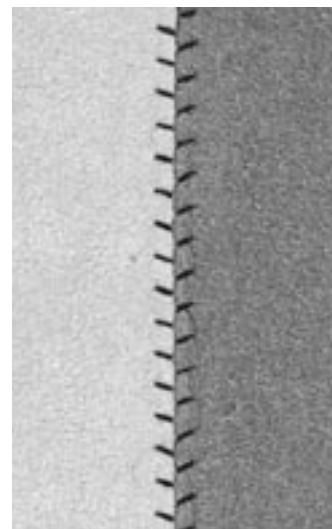

### TIP

- for variety, increase or decrease the length and width of the pre-programmed feather stitch