

BERNINA ACCESSORIES

BERNINA LONGARM ACCESSORIES AT A GLANCE



made to create **BERNINA**

Q 16



A Q 16 longarm quilting machine

Q 20



B Q 20 longarm quilting machine

Q 24



C Q 24 longarm quilting machine



- 1 Frame «small»
- 2 Frame «classic»
- 3 Frame «large»



- 4 Sit down table



Information about the BERNINA accessories catalog

Main categories

In the machine overview, the BERNINA quilting machines are listed and divided into the main categories A, B and C. These categories indicate which of the accessories are compatible with which machine models, frame or sit down combinations. Your BERNINA dealer will be happy to help you choose your accessories.

Example

1. Find your Q Series model in the overview and note the category.
2. Find the required accessory in the Table of Contents and check compatibility based on category.

B



My BERNINA longarm quilting machine Q 20 belongs to category **B**.

- 1 Frame «small»
- 2 Frame «classic»
- 3 Frame «large»
- 4 Sit down table



My Q 20 with the frame «classic» belongs to category **B2**.

My BERNINA longarm quilting machine belongs to category: _____



Chapter 1

For the longarm quilting machine

Embroidery foot #15	5
Free-motion embroidery foot #24	5
Drop-shaped embroidery foot #26	5
Quilting foot #29	6
Free-motion couching foot #43	6
Echo-quilting and CutWork foot #44C	6
Adjustable ruler foot #72	7
Adjustable stippling foot #73	7
Adjustable gliding cup foot #74	7
Ruler foot #96	8
Echo-quilting clips	8
CupClip	8
Couching inserts	9
Universal Pro needles	9
Universal twin needle	9
Stitch plate for twin needle	10
Bobbin case M class	10
Bobbin M class	10
Spool holder horizontal	11
Spool holder vertical	11
USB stick	11
Needle point laser	12
Silicone fluid	12
Oil pen	12

Chapter 2

For the frame

Pantograph kit	14
Ruler work kit	14
Ruler kit for frame models	14
Casters	15
Mechanical channel locks	15
Batting roll holder	15
Hydraulic lift	16
Additional shelving	16
Palm precision handles	17
Zippered leaders	17
Zippered leaders - supplementary kit	17

Chapter 3

For the sit down table

Gripper rings	19
Dust cover	19
Ruler kit for sit down models	19

Frame	21
-------	----

Chapter 4

Frame options

Koala cabinet 29"	23
Koala cabinet, elevated	23
Horn lift table	23
Foldable table, height adjustable	24
Rauschenberger sit down table	24

Chapter 5

Sit down table options

Q-Matic	26
---------	----

Chapter 6

Automation | Q-Matic



FOR THE LONGARM QUILTING MACHINE



Embroidery foot #15



032 708 71 00 A B C

This foot is recommended for appliqué and free-motion quilting. The slight upward tilt in the sole of the foot makes it easier to quilt over uneven areas, like thick seams, appliqués or dense quilting.



Free-motion embroidery foot #24



008 467 74 00 A B C

The open sole offers a free, unobstructed view of the quilting area. Precise and creative free-motion projects such as micro work, embellishments and thread painting can be accomplished with ease. For perfect results use this foot with the palm precision handles.



Drop-shaped embroidery foot #26



031 597 71 00 A B C

This foot with the drop-shaped opening is recommended for dense quilting such as thread painting.

The drop shaped opening and the design of the foot sole reduce the risk of damaging the upper thread, even if the same area is quilted over several times.



Quilting foot #29



008 469 73 00 A B C

This quilting foot is perfect for free-motion quilting. The clear sole ensures an unobstructed view of the entire quilting area, which is important for positioning stitches precisely. The foot is especially suited for free-motion quilting such as filler designs, embellishments or micro work.



Free-motion couching foot #43



031 779 73 00 A B C

The free-motion couching foot is specially designed for appliquéing with cords, yarn and ribbon up to 2 mm in diameter. The cords are fed directly to the needle through a hole in the sole, and they can be sewn on to the quilt in any line or shape.

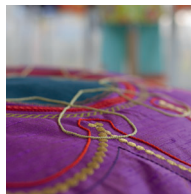

Echo-quilting and CutWork foot #44C



033 369 72 00 A B C

This foot is the ideal companion for numerous of creative quilting projects such as echo and shadow quilting, free-motion quilting, thread painting, and automated quilting with Q-Matic. The rounded transparent sole moves easily over raised areas of fabric. The crosshair and concentric circular markings help position the stitches precisely.



Adjustable ruler foot #72



101 786 70 00 A B C

This foot allows to sew along rulers to create decorative quilt designs such as lines, feathers, circles, etc. Suitable rulers must be at least ¼" thick. The special shape of the foot allows to place the rulers all around the foot, which is especially convenient when quilting a circle. The height of the foot is adjustable and can be adapted.



Adjustable stippling foot #73



104 211 70 00 A B C

The adjustable stippling foot #73 simplifies free-motion quilting when it comes to small designs and detail work. This wide-open foot gives a perfect sightline to the needle insertion point on the fabric. Adjust the height depending on the thickness of your quilt sandwich for perfect stitches. Plus, the matte grey coating dulls any glare, offering a perfect view for quilting success.



Adjustable gliding cup foot #74



104 213 70 00 A B C

The adjustable gliding cup foot #74 is perfect for free-motion, echo and shadow quilting, yarn painting as well as appliqué. The high cup of the foot allows to perfectly glide over applications, thick or uneven seams and embellishments. Furthermore, thanks to the transparent cup, you will have a very good view of the needle and the fabric.

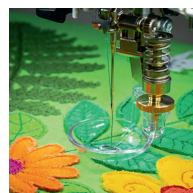

Ruler foot #96



034 316 70 00 A B C

The BERNINA ruler foot #96 is primarily used in combination with ¼" thick acrylic rulers. The high sole prevents the foot from hitting the rulers and the special shape makes it possible to place the rulers all around the foot.

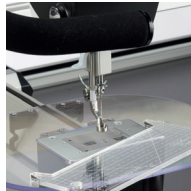

Echo-quilting clips



102 959 71 00 A B C

1x Echo-quilting clip, radius ½ Inch

1x Echo-quilting clip, radius ¾ Inch

1x Echo-quilting clip, radius 1 Inch

The echo-quilting clips are specially designed for quilting with the adjustable ruler foot #72 and the ruler foot #96.

They allow to create fantastic patterns such as crosshatching or parallel lines easily and accurately. In addition, they can also be used in free-motion quilting when quilting around a design with a certain distance.

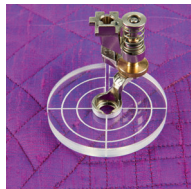

CupClip



103 850 70 00 A B C

The CupClip is the ideal companion to the ruler foot #96 when it comes to pantograph quilting (freehand or computer guided), Q-matic or quilting appliqué quilt tops.

The particular cup shape of the clip will glide easily over uneven, thick or basted parts of the quilt top without getting caught or entangled. Open seams will no longer be a problem and gliding over or along appliqué or embroidery will be trouble free.

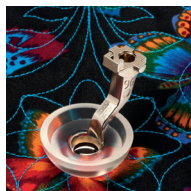

Couching inserts



102 960 70 00	A	B	C
1x Couching insert, Ø 1,4 mm			
1x Couching insert, Ø 1,8 mm			
1x Couching insert, Ø 2,2 mm			

With the couching inserts, yarns, cords, wool or felt threads can be creatively sewn on to your project. The inserts are to be used with the adjustable ruler foot #72 and are attached to the bottom of the sole of the foot.

Thanks to the high-quality material, they are robust and also protect the surface very well when quilting with metallic cords and yarn.

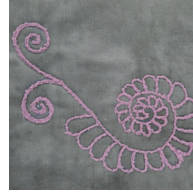

Universal Pro needles



036 152 70 00	A	B	C	(90/14)
036 152 70 01	A	B	C	(110/18)
036 152 70 02	A	B	C	(100/16)

The BERNINA needle assortment includes high quality needles for different materials and applications in different designs and strengths.

The Universal «Pro» needles are particularly suitable for the high speeds of longarm quilting.

Universal twin needle



002 528 71 05	A	B	C	(80/4,0)
002 528 71 06	A	B	C	(90/3,0)
002 528 71 07	A	B	C	(90/4,0)
002 528 71 11	A	B	C	(100/4,0)

For decorative quilting with the BERNINA longarm. The twin needle is to be used with the BERNINA Q Series stitch plate for twin needle and the ruler foot #96.

Stitch plate for twin needle

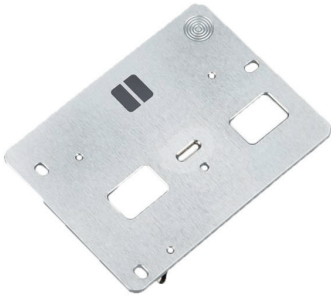

035 904 70 00 A B C

The BERNINA Q Series stitch plate for twin needle is suitable for working with 3 and 4 mm twin needles. It is easy to insert and has openings for the BSR sensors. These ensure even results in your double-thread, decorative stitches.

Bobbin case M class



034 320 71 08 A B C

Bobbin M class for longarm quilting machines. Suitable for M class bobbins.

Bobbin M class



033 210 71 02 A B C (5 pcs.)

The BERNINA M class bobbins have been specially developed for the Q Series and ensure that the lower thread runs smoothly.

Spool holder horizontal



035 901 70 00 A B C

The horizontal spool holder allows to use smaller, parallel wound spools without any problem.

Spool holder vertical



035 902 70 00 A B C

The vertical spool holder gives you extra space for your favorite threads. The vertical spool holder can accommodate two additional spools.

USB stick



104 081 70 00 A B C

The 16GB USB stick is a handy portable storage medium for storing data, quilt patterns and update files.

Needle point laser



102 867 70 00 A B C

The needle point laser indicates the exact spot on the quilt where the needle will pierce.
The puncture site can be hit precisely every time.

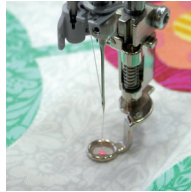

Scan the QR code to see a video tutorial.

Silicone fluid



031 963 50 00 A B C

The use of the thread-lubrication unit is particularly recommended when working with metallic and loosely twisted threads.

The silicone fluid greatly improves the friction properties of these threads and effectively protects delicate threads from damage and breaking.

Oil pen



033 567 70 01 A B C

Regular care ensures that your longarm quilting machine runs smoothly. This includes oiling it with the handy oil pen.

FOR THE FRAME



Pantograph kit



035 886 70 00	B1	B2	B3
	C1	C2	C3

The pantograph kit contains everything you need to sew edge-to-edge quilt patterns with ease.

Create beautiful and professional quilting by following purchased paper patterns or self-created designs.

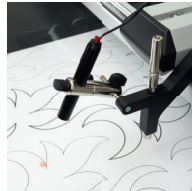

Scan the QR code to see a video tutorial.

Ruler work kit



035 900 70 00	B1	B2	B3
	C1	C2	C3

The ruler work kit includes the ruler base and ruler foot #96 to easily quilt with rulers. In addition, a versatile ruler is included.

Whether using a basic ruler or a special ruler, the ruler work kit will help to achieve professional quilting results.

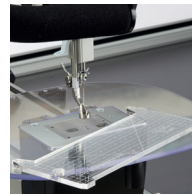

Scan the QR code to see a video tutorial.

Ruler kit for frame models



102 379 70 00	B1	B2	B3
	C1	C2	C3

The rulers are suitable for BERNINA longarm quilting machines on a frame.

The set includes rulers in different sizes and styles. In combination with the ruler work kit, you have the possibility to create countless designs precisely and easily.

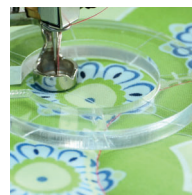

Casters



035 997 70 00	B1	B2	B3	(6 pcs.)
	C1	C2	C3	(6 pcs.)

Equip your quilting frame with casters for quick and easy repositioning. Each caster can be locked individually to hold the quilting frame securely in place.

Mechanical channel locks



035 998 70 00	B1	B2	B3
	C1	C2	C3

The mechanical channel locks make it easier to quilt perfectly straight lines and are also great to place and align the quilt top perfectly straight. They block the movement of the carriage and thus the machine in either horizontal or vertical direction.



Scan the QR code to see a video tutorial.

Batting roll holder



035 994 70 00	B2	C2
035 994 70 01	B3	C3

The batting roll holder is a very useful accessory for your quilting frame.

Batting rolls can be stored under the frame to save space. The batting can then be conveniently placed on to the quilt sandwich without having to cut to size.



Hydraulic lift



90-110V

035 996 70 00*	B2	B3
----------------	----	----

	C2	C3
--	----	----

*USA, CANADA, JAPAN		
---------------------	--	--

The hydraulic lift for the BERNINA quilting frame allows easy adjustment of the working height at the touch of a button. Thus, the height can be individually adapted to different personal heights, working techniques or spatial conditions.



240V

035 996 70 01**	B2	B3
-----------------	----	----

	C2	C3
--	----	----

**EU, UK, AUS, NZ, ZA, CH		
---------------------------	--	--

Additional shelving



035 995 70 00	B2	C2
---------------	----	----

035 995 70 01	B3	C3
---------------	----	----

The additional shelving provides extra storage space for your quilting accessories, such as fabrics, threads, etc.



Palm precision handles



102 020 70 00	B1	B2	B3
	C1	C2	C3

The palm precision handles allow comfortable, controlled guiding of the machine with very small quilting movements. Perfect for quilting small designs, background fillers or embellishments.

The ergonomic shape of the hand controls allows relaxed quilting for a long time.



Scan the QR code to see a video tutorial.

Zippered leaders



102 338 70 01 (small)	B1	C1
102 338 70 00 (classic)	B2	C2
102 338 72 02 (large)	B3	C3

3 zippered main leaders (top, back, take up)
2 additional zipper halves for top, back and take up

The BERNINA zippered leaders have many advantages for the quilter, especially when working on several quilting projects at the same time.

An unfinished quilt project can easily be exchanged with another via the zippers. The unfinished quilt project stays in shape and can be put on the frame again with just a few steps.



Zippered leaders - supplementary kit



103 167 70 01 (small)	B1	C1
103 167 70 00 (classic)	B2	C2
103 167 70 02 (large)	B3	C3

The supplementary kit contains 3 additional zipper halves for the take up, back and top rails.

The kit allows you to prepare additional quilts and zip-load them on to the frame with just a few steps.

FOR THE SIT DOWN TABLE



Gripper rings

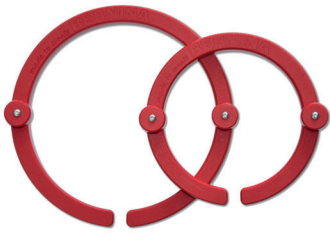

* A4 B4

The gripper rings allow increased control during quilting and precise guiding of larger quilt projects when quilting with the Q Series sit down table models. The area to be quilted is kept completely flat and wrinkle-free. The gripper ring set «made for BERNINA by Martelli» includes an 8" and an 11" ring.

***Only available in select countries.**
Please contact your BERNINA dealer.

Dust cover



103 817 70 00 B4

The Q 20 dust cover is an ideal optional accessory for all customers who want to protect their Q 20 sit down machine from dust when not in use. The dust cover is easy to put in place with a separate cover for the vertical spool holder. The Q 20 dust cover can be used with all BERNINA sit down tables.

Ruler kit for sit down models



102 379 70 01 A4 B4

In combination with the ruler foot #96 or the adjustable ruler foot #72, these handy rulers give you the opportunity to create endless designs accurately. The rulers are suitable for all BERNINA sewing machines as well as for the BERNINA Q Series sit down machines.

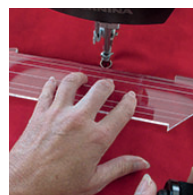

FRAME OPTIONS



Frame



The BERNINA quilting frame with its strong and stable design is ideal for the BERNINA Q Series longarm quilting machines. The BERNINA quilting frame is available in three sizes.



Scan the QR code to see a video tutorial.

024 030 90 10	B1	C1	Frame «small»
024 020 90 10	B2	C2	Frame «classic»
024 040 90 10	B3	C3	Frame «large»

Frame	«small»	«classic»	«large»
Size (length x depth)	9' x 3.9' 2,75 x 1,2 m	12' x 3.9' 3,6 x 1,2 m	13' x 3.9' 4 x 1,2 m
Leader	83" / 6,9' ca. 2,12 m	120" / 10' ca. 3,07 m	132" / 11' ca. 3,36 m
Adjustable working height	35" – 47" 0,9 – 1,2 m	35" – 47" 0,9 – 1,2 m	35" – 47" 0,9 – 1,2 m



SIT DOWN TABLE OPTIONS



Koala cabinet 29"



The quilting table from Koala has a set height of 29". The table can be laterally expanded and the table surface enlarged with additional inserts. This makes quilting of very large quilts easier. Sliding the table top parts to the left and right will give additional storage space.



105 251 70 XX* A B

* Only available in select countries.
Please contact your BERNINA dealer.



English White Ash
105 251 70 00



Asian Golden Teak
105 251 70 01

Koala cabinet, elevated



The quilting table from Koala is steplessly height adjustable from 29"/74 cm until 42"/107 cm. The table can be laterally expanded and the table surface enlarged with additional inserts. This makes quilting of very large quilts easier. Sliding the table top parts to the left and right will give additional storage space.



105 252 70 XX* A B

* Only available in select countries.
Please contact your BERNINA dealer.



English White Ash
105 252 70 00



Asian Golden Teak
105 252 70 02

Horn lift table



The quilting table from Horn of America is steplessly height adjustable. Additional table top leaves towards the front facilitate the quilting of larger quilts and prevent the quilt from sliding down laterally.



* A B

* Only available in select countries.
Please contact your BERNINA dealer.



Foldable table, height adjustable



104 992 70 00 (USA)	A	B
104 992 70 01 (Europa)	A	B

Table size: 36" x 45" (0,91 m x 1,15 m)

The height adjustable foldable table was especially designed for the BERNINA Q Series sit down machines.

The table can handle the weight and speed of the BERNINA Q Series machines with ease, yet it can be stored away in a simple and space-saving way



Adjustable to three different heights:

28" (0.71 m)

30" (0.76 m)

32" (0.81 m)

Rauschenberger sit down table



* A
* Only available in select countries.
Please contact your BERNINA dealer.

Table size: 35,5" x 63" (0,90 x 1,60 m)

This stable and stylish sit down table was designed especially for BERNINA by Rauschenberger.

The sit down table is electrically height adjustable from 30" to 50" (0,82 m to 1,28 m). Optional drawers and worktop extensions are available.

AUTOMATION | Q-MATIC



Q-Matic



101 335 70 00* B2 B3

C2 C3

* Only available in select countries.

Please contact your BERNINA dealer.

This state-of-the-art system for automated quilting comes with more than 600 designs included (incl. Art and Stitch).

The 21,5" all-in-one touch PC mounted to the side of the frame guarantees comfortable access to all designing and placement features. The one-touch quick belt release system allows you to easily switch from automated to freehand quilting.



Scan the QR code to see a video tutorial.



© 2019 BERNINA International AG

1039695.10A.04



103969.51.04

BERNINA

Mettler